

# GPS 92

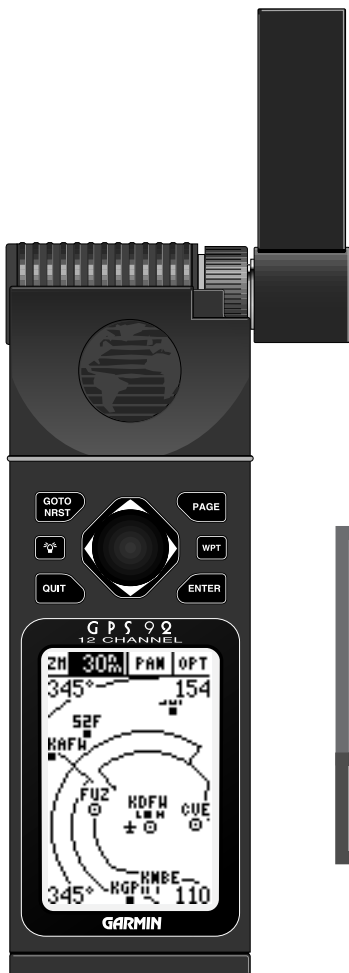

Owner's  
Manual &  
Reference





Software Version 2.01 or above

© 1998 GARMIN Corporation, 1200 E. 151st Street, Olathe, KS USA 66062  
Tel: 913-397-8200 Fax: 913-397-8282

GARMIN (Europe) LTD, Unit 5, The Quadrangle, Abbey Park Industrial Estate,  
Romsey, U.K. SO51 9AQ  
Tel: 011-44-1794-519944 Fax: 011-44-1794-519222

GARMIN (Asia) Corp., 4th Fl., No. 1, Lane 45, Pao-Hsing Road, Hsin Tien,  
Taiwan R.O.C.  
Tel: 011-886-02-917-3773 Fax: 011-886-02-917-1758

Web Site Address: [www.garmin.com](http://www.garmin.com)

All rights reserved. No part of this manual may be reproduced or transmitted in any form or by any means, electronic or manual, including photocopying and recording, for any purpose without the expressed written permission of GARMIN.

Information in this document is subject to change without notice. GARMIN reserves the right to change or improve its products and to make changes in the content without obligation to notify any person or organization of such changes or improvements.

GARMIN, AutoLocate, AutoStore, AutoZoom, PhaseTrac12, and TracBack are all trademarks of GARMIN Corporation and may not be used without the expressed permission of GARMIN.



# GARMIN LIMITED WARRANTY

GARMIN warrants this product to be free from defects in materials and workmanship for one year from the date of purchase. GARMIN will at its sole option, repair or replace any components which fail in normal use. Such repairs or replacement will be made at no charge to the customer for parts or labor. The customer is, however, responsible for any transportation costs. This warranty does not cover failures due to abuse, misuse, accident or unauthorized alteration or repairs. GARMIN assumes no responsibility for special, incidental, punitive or consequential damages, or loss of use.

The warranties and remedies contained herein are exclusive and in lieu of all other warranties expressed or implied, including any liability arising under warranty of merchantability or fitness for a particular purpose, statutory or otherwise. This warranty gives you specific legal rights, which may vary from state to state.

To obtain warranty service, call the GARMIN Customer Service department for a returned merchandise tracking number. The unit should be securely packaged with the tracking number clearly marked on the outside of the package, and sent freight prepaid and insured to a GARMIN warranty service station. A copy of the original sales receipt is required as the proof of purchase for warranty repairs.

Once your standard warranty expires, GARMIN's flat rate service policy provides a low-cost, fast-turnaround factory repair for three additional years. The flat rate is set at the time of purchase, and costs you nothing until you need it. If your GPS receiver should ever need service or repair, return it to a GARMIN service center.

The flat rate service policy applies to the original owner, and is void if the product exhibits any evidence of physical abuse, neglect or intentional damage determined at the sole discretion of GARMIN.

A copy of the original sales receipt is required to verify the service rate in effect at the time of purchase. If a receipt is not available or not included with the unit, it will be repaired at the current three-year flat rate.

Software and database updates are not included in the warranty or flat rate program. GARMIN may, however, change the operating software and/or database at its discretion at no additional cost. Unit repair or replacement will be made at the sole discretion of GARMIN.



Thank you for choosing the GARMIN GPS 92—the best value in compact, full-featured GPS navigation! The GPS 92 represents GARMIN's continuing commitment to provide a quality, affordable airborne navigation system you'll enjoy for years. To get the most out of your new GPS 92, take the time to read through this owner's manual in order to understand the operating features of the unit. This manual is organized into three sections for your convenience.

**Section One** (Getting Started) introduces you to the basic features of the unit and provides a quick-start orientation.

**Section Two** (Simulator Tour) provides a step-by-step lesson in how your new GPS 92 would operate in actual flight by utilizing the built-in simulator.

**Section Three** (Reference) provides details for the advanced features of your GPS 92 by topic. Use this section (and the Index) to review additional information on GPS 92 features as the need arises.

*Before getting started*, check to see that your GARMIN GPS 92 package includes the following items. If you are missing any parts, please contact your dealer immediately.

- GPS 92 Unit
- Quick Reference Card
- Owner's Manual
- Power/Data Cable
- Remote Antenna Mount  
Cable w/ Suction Cup
- Detachable Antenna
- Carrying Strap
- Carrying Case
- "AA" Alkaline Batteries (4)

**Cautions**

**CAUTION:** The GPS system is operated by the government of the United States, which is solely responsible for its accuracy and maintenance. The system is subject to changes which could affect the accuracy and performance of all GPS equipment. Although the GPS 92 is a precision electronic NAVigation AID (NAVAID), any NAVAID can be misused or misinterpreted and therefore, become unsafe.

**Use the GPS 92 at your own risk.** To reduce the risk of unsafe operation, carefully review and understand all aspects of this Owner's Manual and thoroughly practice operation using the simulator mode prior to actual use. When in actual use, carefully compare indications from the GPS 92 to all available navigation sources including the information from other NAVAIDS, visual sightings, charts, etc. For safety, always resolve any discrepancies before continuing navigation.



**NOTE:** This device meets requirements for Part 15 of the FCC limits for Class B digital devices for home or office use. It has been tested for compliance with all necessary FCC standards. This equipment generates, uses, and can radiate radio frequency energy and, if not installed and used in accordance with the instructions, may cause harmful interference to radio communications. However, there is no guarantee that interference will not occur in a particular installation. If this equipment does cause harmful interference to other equipment, which can be determined by turning the equipment off and on, the user is encouraged to try and correct the interference by relocating the equipment or connecting the equipment to a different circuit than the affected equipment. Consult an authorized dealer or other qualified service technician for additional help if these remedies do not correct the problem. Operation is subject to the following conditions: (1) This device cannot cause harmful interference, and (2) this device must accept any interference received, including interference that may cause undesired operation. The GPS 92 does not contain any user-serviceable parts. Repairs should only be made by an authorized service center. Unauthorized repairs or modifications could void your warranty and your authority to operate this device under Part 15 regulations.

## Table Of Contents

<b>Warranty</b> .....	ii
<b>Packing List</b> .....	iii
<b>Cautions</b> .....	iv

### SECTION ONE    Getting Started

Unit Features .....	3
Keypad Usage .....	4
Battery/Antenna Installation .....	5
What is GPS? .....	6
Initializing the Receiver .....	7
Acquiring Satellites .....	8

### SECTION TWO    GPS 92 Takeoff Tour

Power On .....	9
Page Sequence .....	9-10
Simulator Mode .....	10-11
Activating a GOTO .....	11
Navigation Page .....	12
Position Page .....	13
Moving Map Page .....	13-14
Airport Pages and SUAs .....	15-16
Nearest Waypoints .....	16-17
AutoZoom .....	17
Canceling GOTO Navigation .....	17-18
Power Off .....	18

## Table Of Contents

### **SECTION THREE Reference**

Waypoint Categories/Waypoint Information Pages .....	19-25
User Waypoints/AutoStore .....	25-27
Nearest Waypoints, Airspaces, FSS, ARTCC .....	28
GOTO/TracBack Navigation .....	29-32
Route Navigation .....	33-37
Satellite Status Page .....	38-39
Position Page .....	40
Map Page/Map Options .....	41-47
Navigation Page .....	48
Main Menu/Setup Menu .....	49-67
<b>Appendix A—Accessories &amp; Installation</b> .....	68-69
<b>Appendix B—Specifications</b> .....	70
<b>Appendix C—Messages</b> .....	71-72
<b>Appendix D—Map Datums</b> .....	73-74
<b>Appendix E—Index</b> .....	75-76



Unit Features

**Detachable Antenna**

To remove, grab at knurled knob base, rotate 1/4 turn counterclockwise and pull away from side of unit.

**Arrow Keypad**

Moves the cursor and pans the map.

**LCD Display**

On-screen information is referred to as a "page."

**Keypad**

See following page for key descriptions.

**Power/Data Cable Connector (back side)**

Connections for power, ground, serial data in and serial data out.

**Battery Compartment Door**

To open, turn the metal D-ring counterclockwise 1/4 turn. Observe polarity markings on the case.

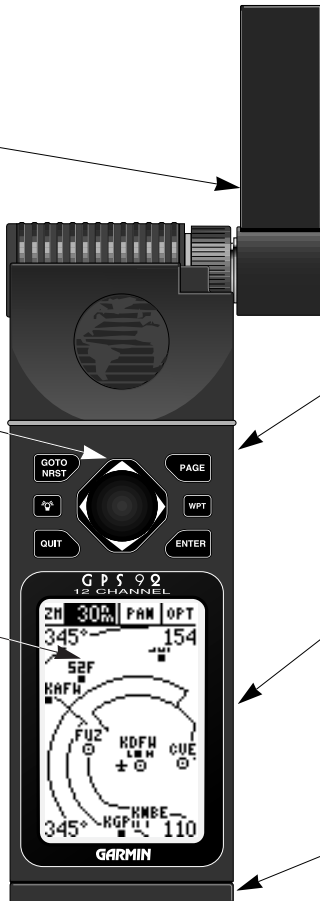

The GPS 92 features a seven-key keypad and a 100 x 64 pixel LCD display. The display can be illuminated for nighttime operation.

Information which appears on the display is referred to as a **page**. A page can include graphics, text or both. The graphic map display may include icons (or symbols) for airport and navaid locations, as well as airspace boundaries.

*Keypad  
Usage*

**(POWER)**— Red key turns the unit on and off, and controls three levels of screen backlighting intensity.

**PAGE**

**(PAGE)**— Scrolls main pages in sequence and returns display from a menu/option to a main page.

**QUIT**

**(QUIT)**— Returns the display to a previous page, cancels an operation or restores a data field's previous value.

**GOTO  
NRST**

**(GOTO/NRST)**— Displays the GOTO waypoint window, allowing you to select the destination waypoint. Press a second time to display the nine nearest airports, VORs, NDBs and intersections, plus nearest FSS and center frequencies. Also provides special-use airspace detail during an airspace incursion. When non-airport nearest information is provided, pressing a third time will instantly return the display to the nine nearest airports.

**WPT**

**(WAYPOINT)**— Retrieves airport or navaid information from the GPS 92's internal database or the user waypoint from memory. Press twice to capture your present position and save as a waypoint.

**ENTER**

**(ENTER)**— Activates a highlighted field to allow data entry. Confirms menu options and data entry.



**(ARROW KEYPAD)**— Controls the movement of the cursor. Used to select options and positions, and to enter data. Press on a particular arrow key once to scroll through data/options slowly. Press and hold an arrow key for faster scrolling.

### Data Entry

Entering data, such as waypoint names, typically begins and ends with the  key. Use the arrow keypad to enter the actual data: UP/DOWN to change the highlighted character, RIGHT to move to the next character.

## Battery Installation

The GPS 92 operates on 4 AA alkaline batteries (included), which are installed at the base of the unit. These batteries provide up to 24 hours of continuous use. Rechargeable NiCad or lithium batteries may also be used. Battery life will vary due to a variety of factors, including temperature and use of screen backlighting. Lithium batteries will provide longer life in colder conditions. The GPS 92 also features an internal 10-year lithium battery which retains your data while changing the AA batteries or when stored with nearly depleted AA batteries.



**NOTE:** The on-screen battery level indicator is calibrated for alkaline batteries, and will not be accurate when using NiCad or lithium batteries (see page 38).

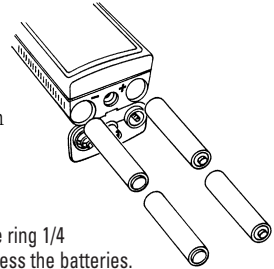

### To install the batteries:

1. Flip up the metal D-ring at the base of the unit, and turn the ring 1/4 turn counterclockwise. Open the compartment door to access the batteries.
2. Install the batteries and close the compartment door. When replacing the GPS 92's batteries, observe the polarity markings engraved in the plastic case. (The indicated polarity represents which end of the battery should be viewable when the compartment door is opened.)
3. Lock the door in the closed position by turning the D-ring 1/4 turn clockwise.

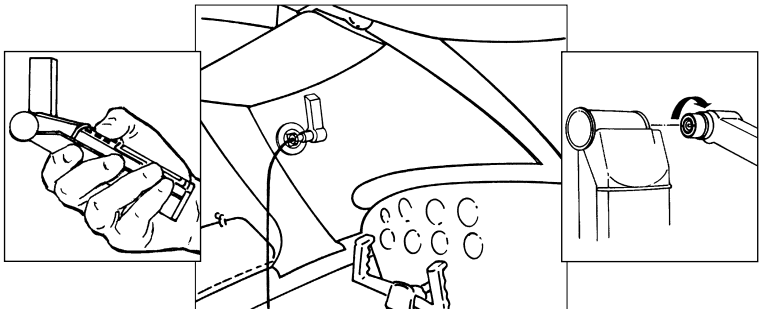

## Antenna Installation and Removal

The GPS 92's detachable antenna can be used directly attached to the unit or detached and used with the suction cup adapter and extension cable. Be sure to attach the antenna at a location which provides good visibility to the sky (satellites), but does not interfere with controls or block your view of instruments. Likewise, observe these precautions when routing the extension cable. The antenna should be oriented as near vertical as possible—perpendicular to the ground.

## What is GPS?

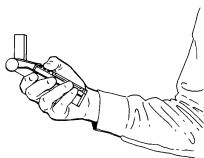

*Hold the receiver at arms length and rotate the antenna perpendicular to the ground.*



*Welcome Page*

The Global Positioning System (GPS) is a constellation of 24 satellites which circle the earth twice a day in a very precise orbit and transmit information back to Earth. This information includes operational status and orbital location of each satellite in the system. The GPS 92 must continuously “see” at least three of these satellites to calculate your position and track your movement. At times, additional satellites may be needed to determine a position.

By using an almanac (a timetable of satellite numbers and their orbits) stored in the receiver’s memory, the GPS 92 can determine the distance and position of any GPS satellite and use this information to compute your position.

Your GPS receiver can only see satellites above the horizon, so it needs to know what satellites to look for at any given time. To use this almanac data, your GPS 92 needs to either be told its general location (be “initialized”) or given the opportunity to find itself. Once you initialize the unit to a position, it will typically compute a fix within a few minutes.

Initialization is only necessary under the following conditions:

- The first time you use your receiver (new from the factory).
- After the receiver has been moved over 500 miles (with the power off) from the last time you used it.
- If the receiver’s memory has been cleared and all internally stored data has been lost.

Because the GPS 92 relies on satellite signals to provide you with navigation guidance, the receiver needs to have an unobstructed, clear view of the sky for best performance. In a nutshell, the GPS receiver’s view of the sky will generally determine how fast you get a position fix—or if you get a fix at all. GPS signals are relatively weak and do not travel through rocks, buildings, hangars, or heavy tree cover, so remember to keep a clear view of the sky at all times for best performance.

## Initializing the Receiver

Once the GPS 92 has calculated a position fix, you'll usually have anywhere from five to twelve satellites in view. The receiver will then continuously select the best satellites in view to update your position. If some of the satellites get blocked, or "shaded," the receiver can simply use an alternate satellite to maintain the position fix. Although a GPS receiver needs four satellites to provide a three-dimensional (3D) fix, it can maintain a two-dimensional (2D) fix with only three satellites. A three-dimensional fix means the unit knows its latitude, longitude and altitude, while a two-dimensional fix means the unit knows only its latitude and longitude.

### Initializing Your GPS 92

To initialize the GPS 92, take the receiver outside and find an open area where the antenna has a clear view of the sky. You may either hold the receiver at a comfortable height with the antenna pointing up, or mount the receiver's antenna on the glare shield and taxi to a clear, unobstructed area.

**To turn the GPS 92 on, press and hold the red  key.**

The Welcome Page will be displayed while the unit conducts a self test. Once testing is complete, the Welcome Page is replaced by the Database Page (which shows the effective date for the Jeppesen database), then by the Status Page.

### EZinit

Your GPS 92 is shipped from the factory to display the "EZinit" initialization *prompt* when first used. After a few seconds, the EZinit *prompt* will appear on the Status Page allowing you to select one of two initialization methods:

- Select Country— allows you to initialize the receiver by selecting your present position from a list of countries in the GPS 92's internal database. This feature provides a position fix in 2-3 minutes.
- AutoLocate— allows the GPS 92 to initialize itself and calculate a position fix without knowing your present position. This feature provides a position fix in approximately 5 minutes.



```

AMERICAS
CYCLE
9804
EFFECTIVE
26 MAR 98
TO
23 APR 98
  
```

The Database Page shows the effective date for the Jeppesen database and coverage area. Updates are available from GARMIN or Jeppesen on a one-time or subscription basis.

```

ACQUIRING EPE
F N
CHOOSE INIT
METHOD:
1 SELECT
  COUNTRY
  FROM LIST
2 AUTOLOCATE
3 NO RE-INIT
  (CONTINUE
  ACQUIRING)
00011123
237358971
  
```

The EZinit *prompt* will automatically appear if the receiver needs to be initialized. The *prompt* may also appear during normal use if the antenna is shaded or the unit is indoors.

Acquiring  
Satellites

Use the arrow keypad to highlight the country or state of your present position from the list and press ENTER.

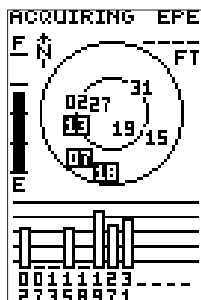

Once satellites have been found, hollow signal strength bars will be displayed while data is being collected. The signal strength bars can be used to help determine if satellites are being shaded.

If the EZinit prompt has not automatically appeared on the status page, press **ENTER**. If you've already initialized the GPS 92 and the EZinit prompt appears, highlight the 'NO RE-INIT' selection with the arrow keypad and press **ENTER**. The EZinit prompt may appear if you've had the unit on in normal mode while indoors, or if the antenna is shaded while acquiring satellites.

**To initialize the receiver:**

1. Use the up or down arrow keys to highlight the 'COUNTRY' option and press **ENTER**.
2. Use the down key to scroll through the country (and state) listings until the country where you are presently located appears. If the country you're in is not listed, select another country within 500 miles of your present position.
3. Press **ENTER** to finish.

**Acquiring Satellites**

The GPS 92 will now begin searching for the appropriate satellites for your position and should acquire a fix within two or three minutes. Verify getting a position fix by watching the status page transition to the position page (provided you haven't pressed any other keys) or by looking for a '2D NAV' or '3D NAV' status at the top-left corner of the status page.

If you have trouble initializing the receiver or getting a position fix, check the following:

- **Does the antenna have a clear view of the sky?**  
If there are large buildings such as hangers, metal surfaces, or other obstructions, the unit may not be receiving enough satellite signals to calculate a fix.
- **Is the right country/state selected from the EZinit list?**

Check for the correct approximate lat/lon on the position page or reselect the appropriate country from the list to restart the initialization.

- **Have you moved more than 500 miles from the last calculated position with the receiver off?**

Reinitialize the receiver, selecting the country/state of your new location from the EZinit list.

**To turn the GPS 92 off, press and hold .**

## GPS 92 Takeoff Tour

The takeoff tour is designed to quickly guide you through basic features and functions of the GPS 92 using a simulated trip.

Once you've completed the tour and become familiar with the main pages and features of the unit, refer to the reference section for complete instructions on installation and performing specific tasks and functions.



The takeoff tour assumes you have initialized the unit and have not changed any of the default settings. If you have changed any settings, the descriptions and pictures used may not match your configuration. You're now ready to power up and take off.

**To turn the GPS 92 on, press and hold the red  key.**

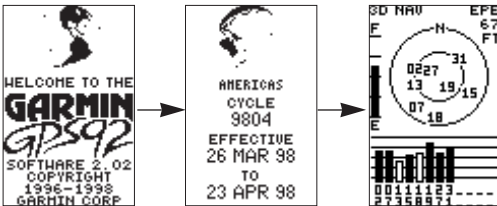
After the unit performs a self-test, the database information page will appear, listing the effective date of the aviation database. After a few seconds, the database information page will be replaced with the satellite status page. The status page provides a visual reference of satellite acquisition and status, with signal strength bars and a satellite view in the center of the screen.



## Scrolling Through the Main GPS Pages

The GPS 92 features five main GPS pages in a continuous loop: satellite status, position, map, navigation, and main menu. Try scrolling through the pages by pressing . You can also scroll in the opposite direction (or return to a previous page) by pressing .

### Important!

*The takeoff tour assumes you are using an Americas database. If you are using an Atlantic International database, try simulating a flight from EGLC to EGSR. For a Pacific International database, try flying PHDH to PHNG. Or try a flight using two airports of your own choosing.*

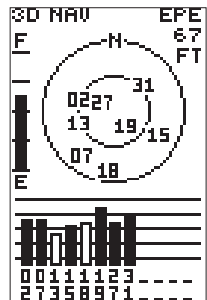

*Use the status page to instantly verify satellite coverage, reception and current signal strength. Position accuracy is also indicated in the upper right-hand corner of the page.*

## Page Sequence

### SETUP MENU

Operation

Nav Units

Position/Datum

Audio/Display

Date/Time

Interface

Nearest Apt

Start from the main menu page's 'Setup Menu' option to select simulator mode.

### OPERATION

Current Mode:

Simulator?

Initial Position

Ref: \_\_\_\_\_

Brg: 000°

Dis: 0.0%

The 'Operation' mode page allows you to enable the built-in simulator and select a starting position for a simulated trip.

### Menu Page

```
MAIN MENU
Setup Menu
Alarms
E6-B Menu
User Wpt List
Routes
Messages
```

### Status Page

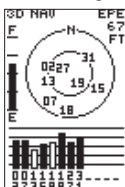

### Position Page

```
10 NW 330 345 N
TRACK SPEED
331° 150%
TRIP ALT
17.5% 2477%
POSITION
N 29°54.780'
W 097°42.689'
TIME
16:32:44
```

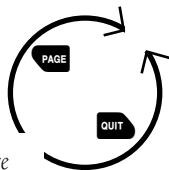

### Navigation Page

```
BRG DST
331° 33.4%
331° 150%
TRK SPD
3R9
0.25 0.25
.....
ETE HTK
13:22 0.00%
16:31
TIME UNAV
```

### Map Page

```
20 50% PAN OPT
331° 34.0
HAUS
HESH
KHVI
50R
TS1
331° 150
```

## Simulator Mode

To continue the Takeoff Tour, you'll need to put the GPS 92 in simulator mode:

1. Press **PAGE** repeatedly until the main menu page appears.
2. Use the up or down arrow keys to move the field highlight to the 'Setup Menu' option and press **ENTER**.
3. Highlight the 'Operation' field and press **ENTER**.
4. Highlight the 'Current Mode' field and press **ENTER**.
5. Use the arrow keys to toggle through the options until you reach 'Simulator' and press **ENTER**.

The field highlight will move to the initial position field, where you can enter the starting position of our simulated flight, Lockhart Municipal Airport (50R, the ICAO identifier), in Lockhart, Texas. Let's see how the data entry process works on the GPS 92:

1. Press **ENTER** to begin data entry. Notice that the highlighted area changes from the entire line to a single character.



- Use the up or down arrow keys to select the first character ('5'). If you press and hold either arrow key, it will scroll through the characters more quickly.



**NOTE:** When entering waypoint identifiers, the GPS 92 will scroll through the available database, displaying any waypoints with the same letters you have entered to that point.

- Press the right arrow key to highlight the next character field. (If you make a mistake, press the left arrow key to back up to the previous character.)
- Repeat steps 2 and 3 until '50R' appears on the reference waypoint field.

Since we'll be taking off from the airport, keep the bearing and distance values at zero to keep your position located at the airport.

#### To return to the main menu page:

- Press **QUIT** twice.

### Activating a GOTO

Once you have entered the starting position of your flight, the next step is to select your GOTO destination, Lakeway Airport (3R9), in Austin, Texas.

- Press **GOTO NRST**.
- The GOTO page will appear with the identifier field ready to accept changes.
- Use the arrow keys to enter the identifier of the destination waypoint ('3R9'). (Remember, up/down arrow keys to change a character, right arrow key to move to the next character field.)
- Press **ENTER** to confirm your destination and activate the simulated navigation.

## TAKEOFF TOUR

### Activating a GOTO

OPERATION
Current Mode: Simulator
Initial Position Ref: 50R____ Brg: 000° Dis: 0.0%

Entering the initial starting position of 50R.

GO TO: 3R9____ -PRESS ENTER TO ACTIVATE NAVIGATION -PRESS GOTO TO SEE NEAREST WAYPOINTS OR SUA
--

Entering the destination waypoint, 3R9.

TAKEOFF  
TOUR

## Navigation Page

BRG	DST
331°	32.4%
356°	150%
TRK	SPD
3R9	
0.25	0.25
.....	
ETE	XTK
20:31	0.00%
TIME	UNAV

In simulator mode, speed may be entered from the navigation page speed field. **NOTE:** Never use simulator mode for actual navigation.

0 NM 330 345 N	
TRACK	SPEED
331°	150%
TRIP	ALT
15.8%	02500%
POSITION	
N 29°53.246'	
W 097°41.719'	
TIME	
16:32:02	

Entering an altitude of 2,500 feet on the position page.

## Navigation Page

Bearing to Waypoint	BRG	DST	Distance to Waypoint
Track Over Ground	331°	33.4%	Speed Over Ground
	331°	150%	
	TRK	SPD	
Relative Bearing Pointer	3R9		CDI Scale
	0.25	↑	0.25
	.....		Crosstrack Error
Estimated Time Enroute	ETE	XTK	VNAV Altitude Field
	13:22	0.00%	
	16:31	---	
	TIME	UNAV	

Once a GOTO is activated, the navigation page will display the bearing and distance to the destination, along with your present speed and ground track. The GOTO destination is listed above the course deviation indicator (CDI), with your estimated time enroute (ETE), cross track error (XTK) and time displayed at the bottom of the page. A relative bearing pointer, located at the center of the CDI scale, points to the direction of your destination.

## Simulated Speed Entry

Now you'll need to enter a speed for the aircraft:

1. Highlight the 'SPD' (speed) field.
2. Press **ENTER** to begin data entry.
3. Use the arrow keys to enter a simulated speed of 150 knots.
4. Press **ENTER** to confirm the selected speed.

Once a speed has been entered, the navigation page will continuously update as we make our way to the destination airport. We now need to enter the cruising altitude of our flight, which can be entered from the position page:

1. Press **PAGE** until the position page appears.
2. Move the field highlight to the 'ALT' (altitude) field and press **ENTER**.
3. Enter an altitude of 2,500 feet using the arrow keys (remember to start with a zero) and press **ENTER** to confirm.

Position &  
Map Pages

## Position Page

The GPS 92's position page displays your present latitude, longitude and altitude, along with your current track and speed over the ground. The top of the page also features a graphic heading indicator, which displays your ground track as you're moving. The time of day, displayed in UTC (zulu) or local time, is indicated near the bottom of the page.

Most of your in-flight navigation with the GPS 92 will center around the navigation and moving map pages. Now that we're on our way, let's move on to the map page by pressing **PAGE**.

## Moving Map Page

The GPS 92's moving map page provides extensive capabilities and information on your present position, nearby facilities and waypoints, and your active route. Let's zoom in for a closer look at our progress:

1. Highlight the 'ZM' (zoom) field—it may be already be highlighted—and press **ENTER**.
2. Press the down arrow key (as often as needed) to change the scale to the 30nm setting, and press **ENTER** to confirm.

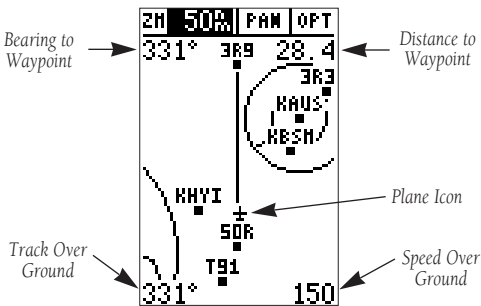

At the 30nm scale, you'll be able to see your plane, nearby airports and airspace boundaries. The line up the center of the page represents the track-up route from your starting point (50R) to the destination airport (3R9), with your present position indicated by the plane icon. Notice that your plane remains centered on the map, while nearby waypoints pass by, based upon your present speed and track.

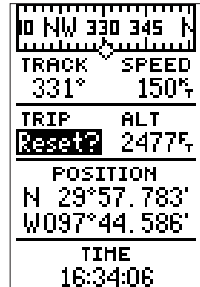

The position page features a resettable trip odometer to keep track of your distance traveled. The trip odometer is resettable, allowing you to keep track of distance traveled from a starting point which you specify. Other options are also available to display average speed (AVSPD), maximum speed (MXSPD), trip time (TTIME) and elapsed time (ELPSD).

Map Page

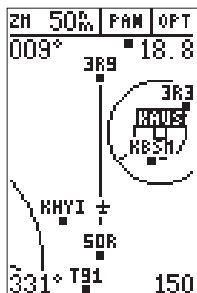
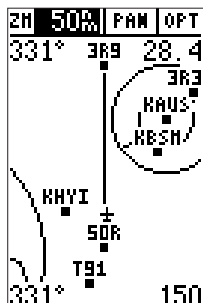

Use the ARROW KEYPAD to select on-screen waypoints by moving the cursor onto the waypoint name.

Whenever a waypoint identifier is highlighted, pressing enter will allow you to review information pages.

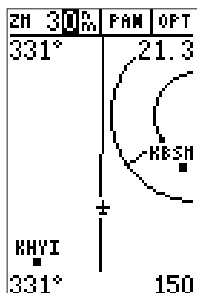

Zooming in to lower scales will show fewer waypoints and make the screen less crowded.

The moving map page can be broken down into three parts: the **zoom, pan and option fields** (located at the top of the page), the **moving map field**, and the **bearing, distance, track and speed fields** (located in the corners of the map). The zoom and pan fields provide access to the map scale and scrolling cursor functions. The option field allows you to determine which items are displayed on the screen, while the moving map field lets you highlight on-screen airports and waypoints for immediate review. The bearing, distance, track and speed fields are display fields only, and do not provide access to other functions.

The default placement of the cursor highlight is on the zoom field. To move the cursor to the pan field or through the on-screen waypoints, simply use the arrow keypad to move in the desired direction, and press **ENTER** to activate the function or review the selected waypoint. Try selecting 'KAUS', just right of our current route, to practice:

1. With the field cursor on the zoom field, press the down and/or up arrow keys until the 'KAUS' identifier field is highlighted.
2. Press **ENTER** to review the waypoint location page for 'KAUS'.

The waypoint location page for 'KAUS' will appear, providing you with the facility's name and location (city/state/region), with the elevation, latitude and longitude of the field, and fuel available (AV, Jet or Mogas). In addition to the location page, each airport in the GPS 92's database features separate communication and runway pages, which are accessible from the prompts located near the bottom of the location page.

**To view the airport communication page for 'KAUS':**

1. Use the left arrow key to highlight 'COMM?' and press



All of the available frequencies for the selected airport will be displayed, with the designation shown at the left of each frequency. If there are more than seven frequencies for a selected airport, use the up and/or down arrow keys to view additional frequencies.

**To view the runway information page:**

1. Press  (repeatedly, if necessary) until the runway information page is selected.

The runway information page features a diagram of the available runways, along with runway length, surface type and lighting for each runway.

**To return to the moving map page:**

1. Move the field highlight to the 'DONE?' prompt and press



Once you're back on the moving map page, you'll notice that our plane is getting close to the special use airspace (SUA) surrounding 'KAUS'.

Whenever you are within 2 nm of an SUA, projected to enter an SUA or inside an SUA, the GPS 92 will notify you with a message and supply detailed information on each SUA you are being alerted to. By looking closely at the map display, you'll notice that we will come very close to the KAUS SUA, but not actually enter it. Once our flight takes us within 2 nm of the SUA, we'll be alerted with a 'Near SUA < 2nm' message (you may have to wait a minute or two to get the message, depending on how fast you've made your way through the tour).

**To view the SUA message:**

1. Press .

To return to the map page, press  again.

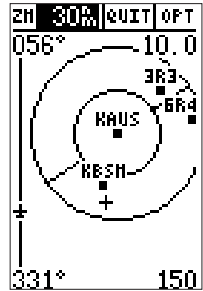

The GPS 92's sectorized airspace boundaries let you watch your proximity to each boundary on the moving map.

Nearest  
Waypoints Page

NRST	ALRM	SUA
1	AUSTIN	
	NEAR < 2 NM	
2	-----	
3	-----	

The nearest SUA page provides information about special-use airspace alerts.

NEAREST	APT	
WAYPNT	BRG	DIS
NRST	087°	10.7
KAUS	055°	11.7
3R9	331°	11.8
KHYI	177°	17.6
3R3	040°	17.8
5R3	347°	19.3
6R4	052°	20.8
8R8	325°	21.4
50R	151°	23.0

The bearing and distance to the nine nearest airports may be quickly accessed on the nearest airport page for use in an emergency or for general information.

Additional information, including the name, class, controlling agency and altitudes, is available from the **GOTO NRST** key. To view additional SUA information:

1. Press **GOTO NRST** twice. The nearest SUA alarm page will appear, which can display up to nine SUA alerts at once. Each listing will display the type of alert and time to intrusion, if applicable.
2. To view specific information on any listed SUA, highlight the desired SUA name and press **ENTER**.

The SUA page will appear, providing additional information on floor and ceiling altitudes for the selected SUA.

3. To return to the nearest SUA list, press **ENTER**.
4. To return to the map page from the SUA list, press **QUIT**.

Alert messages for the various classes of SUAs may be turned off to avoid nuisance alerts, and SUA boundaries may be removed from the map to avoid excess clutter at higher map scales. For complete information and definitions on SUAs, see page 59.

### Nearest Waypoints Page

The nearest waypoints page displays the nine nearest airports, VORs, NDBs, INTs, and user waypoints to your present position, and is extremely useful for locating the nearest facility during an in-flight emergency. In addition, nearest flight services stations (FSS), Air Route Traffic Control Centers (ARTCC), and special use airspace alarms can also be viewed.

To view the nearest waypoints of a particular category, you need to select the desired category from the category field at the top of the nearest page. Let's practice by viewing the nearest airports to our present position:

1. Press **GOTO NRST** twice to display the nearest page. Most likely, it still shows nearest SUA alarm information.
2. Press **GOTO NRST** a third time to immediately select airports as the desired nearest category. This feature is always available to immediately retrieve airport information.
3. To select a different category, highlight 'APT' and press **ENTER**. Use the up and down arrow keys to select the desired category and press **ENTER** to confirm selection.

**AutoZoom &  
Cancel GOTO**

Once you've selected and confirmed a category, the GPS 92 will display the nine nearest facilities and provide the distance and bearing to each waypoint in the list. To scroll and review the nearest waypoints list:

1. Highlight the desired waypoint, using the arrow keypad.
2. Press **ENTER** to review the waypoint page(s).
3. Press **ENTER** again to return to the nearest list. The field highlight will sequence to the next waypoint on the list.
4. To GOTO a nearby airport, highlight the desired waypoint on the list, press **GOTO NEXT** and **ENTER**.
5. Press **QUIT** to exit the nearest function and return to the previously viewed page.

**Auto Zoom**

You will notice that as we make our way toward the destination airport, the map scale will automatically zoom in to provide a closer look at the airport. What you're actually seeing is the GPS 92's AutoZoom feature. Whenever you select a GOTO destination, the map page will default to the 50 nm setting and gradually zoom down the map scale to the 1.2 nm setting.

The map scale will zoom to the next lowest setting (i.e., from 50nm to 30nm) whenever the map can fit both your present position and your destination on the screen.

If you manually zoom in the map scale before this point, the AutoZoom feature will resume once it catches up to the map scale you have selected (down to 1.2 nm).

If the map is manually zoomed out beyond the AutoZoom scale, the AutoZoom will be canceled, and the GPS 92 will assume you want to stay at the scale you have manually selected.

**Canceling GOTO Navigation**

By now, our plane should be approaching '3R9', the destination airport. The map will continue to zoom down to the 1.2 nm scale. To finish the tour and complete our approach, let's move back to the navigation page:

1. Press **PAGE** to display the navigation page.

NEAREST	VOR	
WAYPT	BRG	DIS
AUS	035°	12.8
RND	212°	42.9
SAT	228°	43.1
STU	277°	45.1
GRK	002°	54.8
SSF	211°	60.6
LL0	310°	63.5
L22	346°	65.8
IOU	098°	67.4

Information on the nine nearest VORs is available by selecting the 'VOR' category.

**GO TO:**

■ \_\_\_\_\_

-PRESS ENTER  
TO ACTIVATE  
NAVIGATION

-PRESS GOTO TO  
SEE NEAREST  
WAYPOINTS OR  
SUA

**Cancel GOTO**



Use the LEFT ARROW key to clear the GOTO field and press ENTER to cancel GOTO navigation.

## Power Off



Once we fly past the airport, notice that the GPS 92 continues to provide navigation to '3R9', with the relative bearing pointer and ETE fields indicating we have passed our destination. The GOTO destination may be canceled by activating another GOTO or canceling the current GOTO.

### To cancel the current GOTO:

1. Press .
2. Press the left arrow key once to clear the destination field (pressing the left arrow key clears a selected field when the cursor is in the left most character position).
3. Press  to confirm.

### Power Off

Congratulations! You have now mastered the basic features of the GPS 92 and you're ready to take off with a powerful tool that can help make your flights smoother and more efficient.

**To turn the GPS 92 off, press and hold the red  key. (The unit will count down for two seconds as it shuts off.)**

Thank you for choosing the GARMIN GPS 92. We hope it will be a valuable navigation tool for you, wherever your course may take you.

Be sure to carefully review the sections on installation and the internal database so you can get the most out of your new GPS 92. The takeoff tour has only explored a small part of what this GPS receiver can do for you. The reference section will describe in detail all of the GPS 92's functions and features.



## Waypoint Categories

### Internal Database

The GPS 92 uses an internal Jeppesen® database to provide position and facility information for thousands of airports, VORs, NDBs and intersections. Each facility in the database is stored as a waypoint, with its own latitude/longitude, identifier (up to six letters and/or numbers) and other pertinent information. There are three database coverage areas available for the GPS 92. They are referred to as “Americas”, “Atlantic International”, and the “Pacific International” databases.

The International Civil Aviation Organization (ICAO) and Aeronautical Radio, Inc. (ARINC) break the world into ten geographic regions. The GPS 92 Americas database contains aeronautical information for the group of ICAO regions consisting of North, Central, and South America. The ‘Atlantic International’ database provides information for the ICAO regions of Europe, Africa, Eastern Europe, and the Middle East. The Pacific International database gives information for the ICAO regions of Eastern Europe, Middle East, Pacific, and South Pacific.

### Waypoint Categories

Five categories of waypoint information are available through the  key. Each category provides different types of detailed information for a selected facility:

- **Airports**— Identifier, city/state, country, facility name, position (lat/lon), elevation, fuel services, runways, and communications frequencies.
- **VORs**— Identifier, city/state, country, facility name, position (lat/lon), frequency and co-located DME or TACAN availability.
- **NDBs**— Identifier, city/state, country, facility name, position (lat/lon) and frequency.
- **Intersections**— Identifier, region/country, position (lat/lon) and range/bearing to nearest VOR.
- **User**— Identifier (name), position (lat/lon), user comments and reference waypoint.

To view the waypoint information for a desired waypoint, select the waypoint category from the category field, located at the top left of the waypoint page, next to the identifier field.



AMERICAS  
CYCLE  
9804  
EFFECTIVE  
26 MAR 98  
TO  
23 APR 98

The GPS 92's internal Jeppesen database is available with an Americas, Atlantic International, or Pacific International database. The database cycle is displayed on the database information page. Information on updating the database is included with your GPS 92 package.

WAYPOINT
WPT: AA
AUCKLAND
-----
-----
114.80MHz DME
S 37°00.282'
E 174°48.816'
NEW ZEALND
DONE?

## Entering Waypoint Identifiers

WAYPOINT	
APT: 503	---
LOCKHART TX	
ELEV 530FT	
N 29°51.043'	
W 097°40.334'	
FUEL AV JET	
RUNWAY?	
COMM? DONE?	

Entering a waypoint identifier.

WAYPOINT	
APT: KAUS	---
MUELER, TX	---
AUSTIN TX	
ELEV 630FT	
N 30°17.915'	
W 097°42.095'	
FUEL AV JET	
RUNWAY?	
COMM? DONE?	

Entering a waypoint by facility name.

### To choose a waypoint category:

1. Press **WPT** to display the waypoint page.
2. Highlight the category field.
3. Press **ENTER** to begin selection of the waypoint category.
4. Use the arrow keys and select the desired category.
5. Press **ENTER** to confirm the category selection.

### Entering Identifiers

After a waypoint category is selected, information for a waypoint can be viewed by entering the identifier or name of the desired waypoint. Airports, VORs, and NDBs may be entered by either the identifier, facility name, or the location (city). Intersections and user waypoints must be entered by the identifier.

#### To enter a waypoint identifier:

1. Highlight the identifier field and press **ENTER**.
2. Enter the desired identifier using the arrow keypad, and press **ENTER**.



**NOTE:** As the identifier is entered, the GPS 92 will scroll through the available database, displaying any waypoints with the same identifier letters you have entered to that point. Once the desired waypoint is displayed, press **ENTER**.

After you've selected a waypoint category, waypoint information can also be retrieved by entering the facility name of the airport, the name of the VOR or NDB, or their city location (intersections and user waypoints cannot be retrieved by facility or city name).

#### To select a waypoint by facility or city name:

1. Select the desired waypoint category (APT, VOR or NDB) as described at the top of this page.
2. Highlight the facility name or city name field. Press **ENTER**.
3. Enter the name of the facility or city and press **ENTER**.

Once a waypoint category and identifier have been selected, the GPS 92 will provide extensive information through various waypoint review pages.

## Airport Information

HAYPOINT	HAYPOINT	HAYPOINT
APT: <b>KAUS</b> HUELLER HUN	APT: <b>KAUS</b>	APT: <b>KAUS</b>
AUSTIN TX	1 ATIS 119.20	RUNWAY: LENGTH 13R-31L 7200FT
ELEV 630FT	2 CLM 125.50	SURFACE LIGHTING HARD FULL TIME
N 30°17.915'	3 GND 121.90	
W 097°42.095'	4 THR 121.00	LOCATION? <input type="checkbox"/>
FUEL AV JET	5 UNCH 123.00	COMM? <input type="checkbox"/>
RUNWAY? <input type="checkbox"/>	6 DEP? 118.80	
COMM? <input checked="" type="checkbox"/>	7 DEP? 119.00	
	LOCATION? <input type="checkbox"/>	
	RUNWAY? <input type="checkbox"/>	
	COMM? <input type="checkbox"/>	

Location Page

Communication Page

Runway Page

The GPS 92 features three airport pages:

- **Airport location**— allows entry of desired airport by identifier, facility name or city and displays latitude, longitude, elevation; and fuel availability.
- **Airport communication**— allows entry of desired airport by identifier and displays radio frequencies and any usage restrictions.
- **Airport runway**— allows entry of desired airport by identifier, displays runway designations, length, surface and lighting information, and/or pilot-controlled lighting frequencies.

### To scroll through the airport pages:

1. Select the airport category and enter the desired airport identifier. (The airport page initially displayed will be the same as the last airport page viewed.)
2. Use the left arrow key to move the field highlight to the desired page prompt and press **ENTER**.

Once you have moved from the initial airport page displayed, the page prompt will automatically move forward to the next available prompt. This allows you to continuously cycle through the airport pages by simply pressing **ENTER** repeatedly.

### To exit the airport pages and return to the previously viewed page:

1. Press **QUIT**.

## Airport Information

HAYPOINT
APT: <b>KLAX</b>
LOS ANGELES INTL
LOS ANGELES CA
ELEV 130FT
N 33°56.556'
W 118°24.484'
FUEL AV JET
RUNWAY? <input type="checkbox"/>
COMM? <input checked="" type="checkbox"/>

The internal database uses ICAO identifiers for all airport names. All U. S. airports which contain only letters use the prefix 'K'. For example, Los Angeles International is KLAX under the ICAO standard.

Other airports, such as Otten Memorial (3VS), that contain numbers in the identifier, do not require the 'K' prefix. Many countries outside the U. S. use two letter prefixes. For more information, contact the International Civil Aviation Organization.

**Airport  
Location Page**

WAYPOINT	
APT: KAUS	
1 ATIS	119.20
2 CLNC	125.50
3 GND	121.90
4 THR	121.00
5 UNCH	123.00
6 DEP?	118.80
7 DEP?	119.00
LOCATION?	
RUNWAY? DONE?	

In some instances, all available frequencies for a selected airport may not fit on the communication page. Use the UP or DOWN ARROW keys to scroll through and view any additional frequencies.

FREQUENCY INFO	
BEARING	
171° - 002°	
ALTITUDE	
NONE	
NARRATIVE	
NONE	

Frequency types followed by a question mark (?) have usage restrictions. To view the restriction information, highlight the frequency type and press ENTER.

**Location Page**

The diagram shows a screen display for the 'WAYPOINT' location page. Callouts point to various fields:

- Facility Name (selectable):** Points to the text 'WAYPOINT' at the top.
- Identifier Field (selectable):** Points to the text 'APT: KAUS' and 'MUELLER MUN'.
- City/State (selectable):** Points to the text 'AUSTIN TX'.
- Elevation & Position:** Points to the text 'ELEV 630FT', 'N 30°17.915'', and 'W097°42.095''.
- Available Fuel Types:** Points to the text 'FUEL AV JET'.

Other visible text includes 'RUNWAY?' and 'COMM? DONE?'.

The GPS 92's airport location page displays the latitude, longitude and elevation of the selected airport, as well as fuel availability. From the airport location page, you can enter a desired airport by identifier, facility name or city as described on page 20. The following descriptions/abbreviations are used on the airport position page:

- Elev— MSL elevation in feet or meters
- Position— In the currently selected position format. (Default format is latitude/longitude in degrees and minutes. See page 52.)
- Fuel— Lists the types of fuel available at the airport:
  - ① AV gas— 80-87 octane, 100 LL, 100-130 octane
  - ② JET— Jet A, Jet A-1 or Jet A+
  - ③ MOGAS— 87 octane unleaded

**Airport Communication Page**

The airport communication page (shown at left) displays radio frequencies and their usage for the selected airport, and allows entry of a desired airport by identifier only. The following frequencies are displayed if available:

- ATIS
- Ground
- Tower
- Unicom/Multicom
- Pre-Taxi
- Clearance Delivery
- Approach
- Departure
- Arrival
- Class B
- Class C
- CTA
- TMA
- TRSA

## Runway Page

**Runway Page**

The last airport page is the runway page, which features a diagram of available runways, along with designations, length, surface and lighting information for the selected airport.

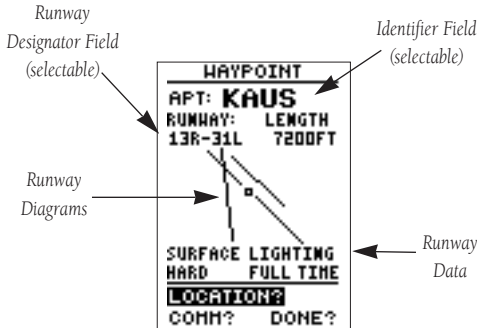

The runway diagram provides a north-up graphic of available runways, with length, surface and lighting data listed below the runway designation. The 'SURFACE' field will display one of the following surface types: hard, turf, sealed, gravel, dirt, soft, unknown or water. The 'LIGHTING' field will indicate one of five lighting schemes: part time, full time, pilot controlled (with frequency), no lighting or unknown.

If a selected airport has more than one runway, additional runways can be viewed by selecting another runway from the designation field.

**To view additional runways:**

1. Highlight the runway designation field.
2. Press **ENTER**.
3. Use the arrow keypad to toggle through and select the desired runway.
4. Press **ENTER** to confirm the selected runway and return the cursor to the 'DONE?' prompt.



Additional runways are accessed through the runway designation field.

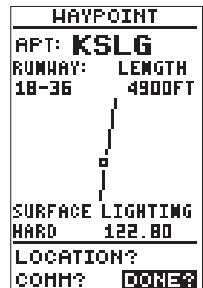

Pilot-controlled lighting with listed frequency.

## Intersections, NDBs & VORs

WAYPOINT	
INT: <b>OTTER</b>	
N 38°51.498'	
W 095°32.010'	
REF: TOP	
BRG	DST
178°	16.7%
M GEN USA	
<b>DONE</b>	

Intersection Page

WAYPOINT	
NDB: <b>EN</b>	
CODEE	
KEMOSHA HI	
389.0KHz	
N 42°33.621'	
W 088°01.729'	
GR LKS USA	
<b>DONE</b>	

NDB Page

### Intersection Information

The intersection waypoint page allows entry of a desired intersection by identifier, and displays position and nearest VOR data for a selected intersection.

#### To view waypoint information on an intersection:

1. Select the intersection ('INT') category from the waypoint category field.
2. Enter the identifier of the desired intersection and press **ENTER**.

The unit will display the intersection's latitude and longitude below the identifier field, and calculate the bearing and distance to the nearest VOR. (Note that the displayed VOR may not be the VOR used to define the intersection.) The region and country of the intersection will also be displayed at the bottom of the page to help you confirm the location in the event of duplicate identifiers.

### NDB Information

The NDB waypoint page allows you to select a desired NDB by entering the identifier, facility name or city. In addition to displaying the identifier, facility name and city/state of the NDB, the NDB page will show the latitude and longitude of the facility, the region/country, and the frequency.

#### To view waypoint information on a NDB:

1. Select the 'NDB' category from the waypoint category field.
2. Enter the identifier, facility name (on the second line) or city (on the third line) of the desired NDB and press **ENTER**.

### VOR Information

The VOR waypoint page allows you to enter a VOR by identifier, facility name, or city name and displays the selected facility's position, frequency and other information.

#### To view waypoint information for a VOR:

1. Select the 'VOR' category from the waypoint category field.
2. Enter the identifier, facility name or city of the desired VOR and press **ENTER**.

## VORs & User Waypoints

The VOR page lists the identifier, facility name and city/state at the top of the page, with the transmitting frequency of the facility listed below. If DME or TACAN equipment is co-located at the site, it will be indicated next to the transmitting frequency of the VOR. The latitude and longitude are also displayed, with the region and country indicated near the bottom of the page.

### User Waypoint Information

The last waypoint category available from the GPS 92's **WPT** key is user waypoints. The user waypoint page allows entry of a desired waypoint by name/identifier and displays the waypoint's position, user comments and a reference waypoint field to calculate the distance and bearing to any other waypoint in the database. The user waypoint page can also be used to create up to 500 waypoints by manually entering a position or defining a range and bearing from an existing waypoint.

#### To view waypoint information for a user waypoint:

1. Select the 'USR' category from the waypoint category field.
2. Enter the identifier/name of the desired user waypoint.
3. Press **ENTER**.

The user waypoint page allows you to create new waypoints using one of three available methods:

- Enter the exact coordinates for the new waypoint's position.
- Enter a distance and bearing from another waypoint already in memory.
- Enter a distance and bearing from your present position.

The first step in creating a new waypoint (regardless of what method you're using) is to assign a name/identifier for the new waypoint.

#### To create a new waypoint from the user waypoint page:

1. Select the 'USR' category from any waypoint category field and press **ENTER**. The highlight will advance to the name field.

WAYPOINT	
VOR:	<b>HAF</b>
	MIDLAND
	MIDLAND TX
-----	
	114.80MHz DME
	N 32°00.551'
	W 102°11.432'
-----	
	S GEN USA
	<b>DONE</b>

VOR waypoint page

WAYPOINT	
USR:	<b>GARMIN</b>
	N 38°51.333'
	W 094°47.941'
-----	
REF:	-----
BRG	DST
018°	513m
-----	
RENAME?	NEW?
DELETE?	<b>DONE</b>

User waypoint page

## Creating User Waypoints

WAYPOINT	
USR:	TOWER
-----	
REF:	-----
BRG	DST
---	---
-----	
RENAME?	NEW?
DELETE?	DONE?

Entering a new user waypoint's name.

WAYPOINT	
USR:	TOWER
-----	
N 38°53.766'	
W 095°10.490'	
-----	
REF:	-----
BRG	DST
151°	2.52m
-----	
RENAME?	NEW?
DELETE?	DONE?

Entering a new user waypoint's position.

2. Press **ENTER** and enter the waypoint name using the arrow keypad.
3. Press **ENTER** to accept.

Once the name has been accepted, the field highlight will move to the position field, where you can manually enter the position of the new waypoint:

4. Press **ENTER** and enter the latitude/longitude using the arrow keypad.

After the latitude and longitude entry is complete, press **ENTER** to save the new waypoint. If you are defining the new waypoint position by referencing (entering a distance and bearing from) a known waypoint or your present position, skip step 4 above and follow these steps:

4. Highlight the 'REF' field and press **ENTER**.
5. If you are referencing a waypoint, enter the identifier of the reference waypoint. (If you want to reference your present position, leave the 'REF' field blank.)
6. Press **ENTER**. The field highlight will advance to the bearing (BRG) field.
7. Press **ENTER** and enter the bearing to the new waypoint from the reference position.
8. Press **ENTER** to confirm the bearing. The field highlight will move to the distance (DST) field.
9. Press **ENTER** and enter the distance to the new waypoint from the reference position.
10. Press **ENTER** to confirm the distance. The GPS 92 will calculate the coordinates of the waypoint and store it in memory.

### User Comments

Once a new user waypoint is saved, the unit will assign a default user comment (the date and time of creation) to the new waypoint. You can replace the default comment with your own 16-character comment at any time, right from the user waypoint page.

#### To enter a user comment:

1. Highlight the comment field and press **ENTER**.
2. To clear the default comment, press the left arrow key when the cursor is in the left most character position.
3. Enter the comment and press **ENTER**.



## User Waypoints & AutoStore

The delete and rename prompts, located near the bottom of the user waypoint page, allow you to quickly remove a waypoint from memory or change the name of an existing waypoint.

### To delete the currently selected user waypoint:

1. Highlight 'DELETE?' and press **ENTER**.
2. Highlight 'YES?' and press **ENTER** to confirm.

The user waypoint page also allows you to rename any user waypoint in memory.

### To rename the currently selected user waypoint:

1. Highlight 'RENAME?' and press **ENTER**. The rename waypoint page will appear.
2. Enter the new waypoint name and press **ENTER**. The highlight will advance to the 'Yes?' prompt.
3. Press **ENTER** to accept the name, or **QUIT** to cancel.

## Creating Waypoints with AutoStore

The **WPT** key is also used to save new waypoints using AutoStore. AutoStore allows you to quickly store your present position and add the new waypoint to a selected route if desired.

### To save your present position using AutoStore:

1. Press **WPT** twice to capture your position (if you're already on a waypoint page, you'll only need to press the **WPT** key once).

The AutoStore page will appear, showing the captured position and a default 3-digit waypoint name. To change the default position name:

2. Highlight the name field and enter the name.
3. Press **ENTER**. The highlight will move to the 'route' field.

### If you'd like to add the waypoint to a route:

1. Press **ENTER** and enter the desired route number using the arrow keypad and press **ENTER** to confirm.

### To save the AutoStore waypoint:

1. Highlight the 'SAVE?' field and press **ENTER**.

WAYPOINT	
USR:	GOLF
N	38°53.054'
W	103°26.365'
13-APR-98 19:56	
REF:	KGLY
BRG	DST
277°	02. <b>1</b> M
RENAME?	NEW?
DELETE?	DONE?

Entering a distance from a reference waypoint.

AUTOSTORE	
Waypoint:	
<b>001</b>	
N	32°13.697'
W	099°13.014'
Add to route	number: <b>--</b>
<b>SAVE?</b>	

AutoStore Page

## Nearest Pages

<b>NEAREST</b>	<b>FSS</b>
<b>FACILITY</b> FT WORTH	
<b>BRG</b>	<b>DST</b>
292*	24.7%
<b>FREQUENCY</b>	
122.65	

Nearest FSS Page

<b>NEAREST</b>	<b>CTR</b>
<b>FACILITY</b> FT WORTH	
<b>BRG</b>	<b>DST</b>
153*	31.5%
<b>FREQUENCY</b>	
127.45	



Nearest ARTCC Page

Nearest Pages

The  key provides detailed information on the nine nearest airports, VORs, NDBs, INTs, and user waypoints from your present position, and is extremely useful for locating the nearest facility during an in-flight emergency. In addition, nearest flight service stations (FSS), Air Route Traffic Control Centers (ARTCC), and special-use airspace alarms can also be viewed.

To view the nearest waypoints of a particular category (airports, VORs, NDBs, intersections or user waypoints), you need to select the desired category from the category field at the top of the nearest page.



**To view a nearest waypoints list:**

1. Press  twice to display the nearest page.
2. Press  to begin selection of the desired category.
3. Press the up or down arrow key repeatedly to scroll through the waypoint categories until the desired category appears in the category field.
4. Press  to confirm the category. The field highlight will move to the first waypoint on the list.

Nearest Flight Service Station/ARTCC

The nearest function also gives you detailed information on the nearest FSS or ARTCC. The nearest FSS or ARTCC page displays the facility name, bearing and distance from your present position, and the facility's frequencies. To view the nearest FSS or ARTCC, you need to select 'FSS' or 'CTR' from the category field at the top of the nearest page.

**To view nearest FSS or ARTCC information:**

1. Press  twice to display the nearest page.
2. Press  to begin selection of category.
3. Press the down arrow key repeatedly to scroll through the categories until 'FSS' or 'CTR' appears in the category field.
4. Press  to confirm the category. The field highlight will move to the frequency field.

## Going To a Destination

One of the many benefits of GPS navigation is the ability to fly directly to a waypoint or fly along a chain of waypoints without relying totally on ground-based navigation aids. To take advantage of the convenience and efficiency of point-to-point GPS navigation, the GPS 92 provides three methods of selecting a destination for your flight: GOTO, TracBack and route navigation.

The GOTO function provides a fast way to set a course to a destination from your present position, while the route function allows you to create a chain of waypoints to follow in sequence toward a selected destination.

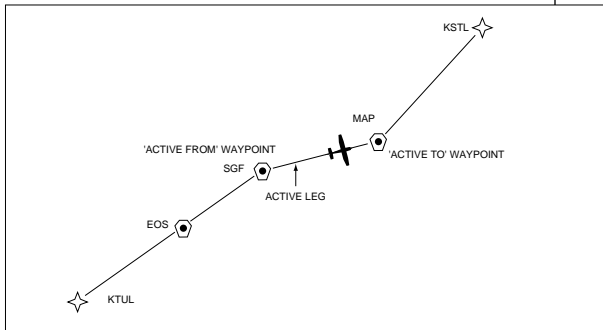

Whether you're flying a GOTO course or a route, there are a few basic concepts and terms that apply to all point-to-point GPS navigation. Routes are broken down and navigated in smaller segments called "legs". The diagram above shows a basic route consisting of five waypoints and four legs.

The waypoint you are going to in a leg is called the "active to" waypoint (MAP), and the waypoint immediately behind you is called the "active from" waypoint (SGF). The line between the "active to" and the "active from" waypoint is called the "active leg". When you activate a route with the GPS 92, it will automatically select the route leg closest to your position as the active leg, and provide navigation guidance directly to the "active to" waypoint of that leg.

*GOTO Key*

**GO TO:**

█ \_\_\_\_\_

-PRESS ENTER  
TO ACTIVATE  
NAVIGATION

-PRESS GOTO TO  
SEE NEAREST  
WAYPOINTS OR  
SUA

To cancel GOTO navigation, use the LEFT ARROW key to clear the identifier field, and press ENTER.

NEAREST	APT	
WAYPNT	BRG	DIS
REST	087°	10.7
KAUS	055°	11.7
3R9	331°	11.8
KHYI	177°	17.6
3R3	040°	17.8
5R3	347°	19.3
6R4	052°	20.8
88R	325°	21.4
50R	151°	23.0

You may access the nearest waypoints page from the GOTO page by pressing the GOTO key a second time.

**GOTO Function**

The GPS 92's GOTO function lets you choose any stored waypoint as a destination and quickly set a course from your present position. Once a GOTO has been activated, the navigation page will provide you with steering guidance to your destination.

**To activate the GOTO function:**

1. Press **GOTO NRST**.
2. The GOTO page will appear with the waypoint field ready to select a destination. Enter the identifier of the destination waypoint using the arrow keypad.
3. Press **ENTER** to confirm the waypoint and display the navigation page.

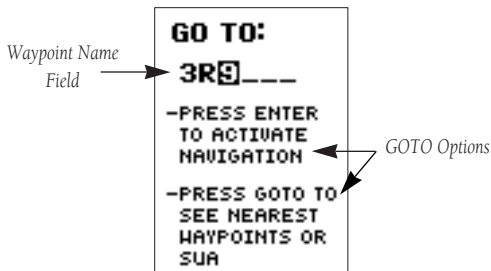

You can also quickly activate the GOTO function from any other page by simply highlighting an identifier, pressing the **GOTO NRST** key and confirming the GOTO page. This method can be used to re-center the CDI on the destination waypoint, or to manually “skip ahead” to a different route waypoint (and resume the remainder of the route in sequence).

Once a GOTO is activated, the GPS 92 will provide navigation guidance to the selected waypoint until the GOTO is cancelled.

**To cancel an active GOTO:**

1. Press **GOTO NRST**.
2. Use the left arrow key to clear the field.
3. Press **ENTER** to complete the cancellation.

## TracBack Navigation

### TracBack Navigation

Another method of navigating to a destination is by using the TracBack function. TracBack allows you to quickly and easily retrace your path using the track log automatically stored in the receiver's memory. The advantage of TracBack is to eliminate the need to mark waypoints along the way and manually create and activate a route back to where you began your trip.

The TracBack route is created by reducing your current track log into a route of up to 30 waypoints, and activating an inverted route along those points. Once activated, a TracBack route will lead you back to the oldest track log point stored in memory, so it's usually a good idea to clear the existing track log at the start of your current trip before you take off.

#### To clear the track log and define a starting point for a TracBack route:

1. From the map option page (see page 44), highlight the 'TRACK LOG' option. Press **ENTER** to access the track setup page.
2. Use the up arrow key to highlight the 'CLEAR LOG?' option.
3. Press **ENTER**. The clear log confirmation page will appear. Use the left arrow key to highlight the 'Yes?' prompt and press **ENTER**.

#### To activate a TracBack route:

1. From the map option page, highlight the 'TRACK LOG' option. Press **ENTER** to access the track setup page.
2. Highlight the 'TRACBACK?' option and press **ENTER**.

Once TracBack has been activated, the unit will take the track log currently stored in memory and divide it into segments called "legs". Up to 30 temporary waypoints (e.g., 'T001') will be created to mark the most significant features of the track log in order to duplicate your original path as closely as possible. A TracBack route from your present position to the oldest track log point will be created as the active route (the active route page will appear), and provide steering guidance to each waypoint back to the starting point of your track log.

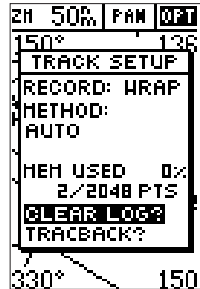

To define the starting point for TracBack navigation, clear the track log at the beginning of each trip.

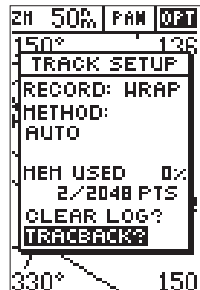

To begin navigation of a TracBack route, highlight the 'TRACBACK?' prompt and press ENTER.

## TracBack Navigation

ACTIVE ROUTE			
TRACBACK			
WAYPNT	ETE	DST	
T002	---	---	---
T001	00:57	2.35	
-----	---	---	---
-----	---	---	---
-----	---	---	---
-----	---	---	---
-----	---	---	---
-----	---	---	---
-----	---	---	---
CLR? INV? ACT?			

The TracBack function allows you to navigate your track log back to the oldest track point in memory.

ROUTE: 0			
TRACBACK			
NO	WAYPNT	DTR	DST
1	T002	150'	3.0
2	T001	.	.
3	-----	---	---
4	-----	---	---
5	-----	---	---
TOTAL DST			3.01
COPY TO: <input checked="" type="checkbox"/> ?			
CLR? INV? ACT?			

To save a TracBack route, be sure to copy route 0 to another route. To save a temporary waypoint, simply rename it following the instructions on page 27.

### Tips on Creating and Using the TracBack Feature

The GPS 92's TracBack feature is designed to help you quickly create and activate a route that follows your path back to a user-defined starting point. To get the most out of the TracBack feature, remember the following tips:

- Always clear your track log at the exact point which you will want to go back to (airport, landing field, etc.).
- The 'RECORD' option on the track log setup page must be set to 'WRAP' or 'FILL'.
- There must be at least two track log points stored in memory to create a TracBack route.
- If there are not enough available waypoints in memory to create a TracBack route, you will be alerted with a 'waypoint memory full' message. The receiver will use any available waypoints to create a TracBack route with an emphasis on the track log closest to the destination (the oldest track log point in memory).
- If the 'CRITERIA' option on the track log setup page is set to a time interval, the TracBack route may not follow your exact path (keeping the criteria set to 'AUTO' will always provide the best TracBack route).
- If the changes in direction and distance of your track log are very complex, 30 waypoints may not be enough to accurately mark your exact path. The receiver will then assign the 30 waypoints to the most significant points of your track and simplify segments with fewer changes in direction.
- If you want to save a TracBack route, copy route 0 to an open storage route before activating another TracBack. Activating another TracBack or storage route will overwrite the existing TracBack route.
- Whenever a TracBack route is activated, the receiver will automatically erase any temporary waypoints (e.g., 'T001') that are not contained in routes 1-19. If there are temporary waypoints stored in routes 1-19, the receiver will create any new temporary waypoints using the first three-digit number available.

## Route Pages

**Route Definition Page**

The GPS 92 lets you create and store up to 20 routes of 30 waypoints each. Routes are created, copied and edited through the route definition page, which is accessed through the main menu page.

**To select the route definition page:**

1. Press **PAGE** until the main menu page appears.
2. Use the arrow keypad to highlight the 'Routes' option.
3. Press **ENTER** to display the routes page.
4. To return to the main menu page, press **QUIT**.

ROUTE: 2			
H34 TO H17			
NO	WAYPNT	DTH	DST
1	H34	091'	54
2	H44	163'	74
3	H17		
4	-----	---	---
5	-----	---	---
TOTAL DST			129
COPY TO:			
CLR? INV? ACT?			

Route Number: 2

Route Comment Field: H34 TO H17

Route Waypoints: H34, H44, H17

Distance for each Route Leg: 091', 163'

Desired Track for each Route Leg: 54, 74

Total Route Distance: 129

'COPY TO' field: CLR? INV? ACT?

AUTOSTORE	
Waypoint:	
001	
N 32°20.165'	
W 099°17.359'	
Add to route number: 8	
SAVE?	

A route may also be created using the GPS 92's AutoStore function. Simply enter a route number in the route field before saving the waypoint.

**Note:** If you enter the number of an existing route, the waypoint you are adding will be added to the end of that route. It will not be geographically placed between the beginning and end of the route.

The route number field is displayed at the top of the page, with a 16-character comment field below. If no user comment is entered, the field will display the first and last waypoint in the route. The waypoint list accepts up to 30 waypoints for each route, with fields for desired track and distance between legs. (If the leg distance exceeds 999 nm, the field will remain blank.)

Below the waypoint list are the route page function fields which let you copy, clear, invert or activate the displayed route. Routes 1-19 are used as storage routes, with route 0 always serving as the active route you are navigating. If you want to save a route currently in route 0, be sure to copy it to another open route, as it will be overwritten by the next route activation.

## Creating & Copying Routes

ROUTE: 1			
K34 TO K31			
NO	WAYPNT	DTR	DST
1	K34	235'	229
2	OK79	035'	15
3	K31		
4	K30		
5			
TOTAL DST			244
COPY TO: --			
CLR? INV? ACT?			

You can construct a route manually by entering the names of individual waypoints in the order you wish to fly them.

ROUTE: 1			
K34 TO K34			
NO	WAYPNT	DTR	DST
1	K34	235'	229
2	OK79	035'	15
3	K31	054'	215
4	K34		
5			
TOTAL DST			459
COPY TO: 1?			
CLR? INV? ACT?			

To copy a route, simply highlight the 'COPY TO:' field, press ENTER, and enter the route number.

### Creating a Route

The route definition page is used to create up to 20 routes of 30 waypoints each.

#### To create a route:

1. Highlight the route number field at the top of the page and press **ENTER**.
2. Select the desired route number and press **ENTER**.
3. The route comment field is highlighted. If you wish to enter a comment (or description) for the route, press **ENTER**, enter your comment and press **ENTER** to confirm.
4. Highlight the first route waypoint name field (if not already highlighted), press **ENTER**, enter the name of the first route waypoint and press **ENTER** to confirm.
5. Continue entering the rest of your waypoints in order. You may enter up to 30 waypoints in each route.
6. After you have finished entering all your waypoints, press **PAGE** to return to the menu page.

### Copying and Clearing Routes

The route definition page is also used to copy a route to another route number. This feature is useful when you make changes to the active route (route 0) and want to save both the new route and the original route.

#### To copy a route:

1. Highlight the route number field at the top of the page and press **ENTER**.
2. Select the desired route number and press **ENTER**.
3. Move the field highlight to the 'COPY TO' field and press **ENTER**.
4. Use the arrow keypad to scroll through the available routes and select a destination route number. Only open routes will be available as choices.
5. Press **ENTER** to copy the route.
6. Press **PAGE** to return to the menu page.



## Clearing & Activating Routes

### Clearing a Route

The route action fields, located near the bottom of the route definition page, allow you to clear, invert and activate the routes stored in the GPS 92.

#### To clear a route:

1. Highlight the route number field at the top of the page, press **ENTER**, select the desired route number and press **ENTER** again.
  2. Highlight the 'CLR?' field and press **ENTER**.
- A warning page will appear, asking you to confirm that you want to remove all waypoints from the route.
3. Highlight the 'Yes' field with the left arrow key and press **ENTER**.
  4. Press **PAGE** to return to the main menu page.

### Activating or Inverting a Route

After a route has been entered in the GPS 92, it can be activated in its sequence or inverted (in reverse order). The process of activating or inverting a stored route takes a storage route (routes 1-19) and copies it into the active route (route 0) for navigation.

This system allows you to have an active route that you may edit during navigation and save as an entirely new route from the original. You will have to copy the active route to an unused storage route to save it, since new route or TracBack activation overwrites route 0.

#### To activate a route:

1. Select the route definition page and press **ENTER** to activate the route number field.
2. Select the route number to be activated and press **ENTER**.
3. Highlight the 'ACT?' field and press **ENTER**.

Inverting a route allows you to navigate route legs in reverse order without editing the original route.

#### To activate a route in inverted order:

1. Follow the same steps as above, but select the "INV?" field and press **ENTER**.



To confirm clearing (deleting) a route, highlight the 'Yes?' prompt and press **ENTER**.

ROUTE: 2			
H34 TO H17			
NO	WAYPNT	DTK	DST
1	H34	091'	54
2	9H4	163'	74
3	H17		
4	-----	---	---
5	-----	---	---
TOTAL DST			129
COPY TO: --			
CLR? INV? ACT?			

To activate a route, highlight the 'ACT?' prompt and press **ENTER**.

## Active Route Page

ACTIVE ROUTE		
K34 TO H17		
WAYPNT	ETE	DST
K34	---	---
K34	29:14	53.6
H17	01:10	128
-----	---	---
-----	---	---
-----	---	---
CLR? INV? ACT?		

### Active Route Page

Use the active route page to keep track of the estimated time enroute and distance to upcoming waypoints.

ACTIVE ROUTE		
K34 TO H17		
WAYPNT	ETA	DST
K34	---	---
K34	20:43	53.1
H17	21:24	128
-----	---	---
-----	---	---
-----	---	---
CLR? INV? ACT?		

The active route page can be configured to display the ETA for each route waypoint.

## Active Route Page

Once a route has been activated, the active route page will appear, displaying the waypoint sequence of your route with the estimated time enroute (ETE) at your present speed and distance to each waypoint. As long as you are navigating an active route, the active route page will become part of the main page sequence of the unit.

The active route page will also allow you to change the ETE field to display desired track (DTK) or estimated time of arrival (ETA) for each leg. You can also clear or invert the active route.

### To display DTK or ETA for each leg:

1. Highlight the 'ETE' field and press **ENTER**.
2. Use the up or down arrow keys to select 'DTK' or 'ETA' and press **ENTER**.

### To invert a route from the active route page:

1. Press the up arrow key once to move the field highlight to the 'INV?' field.
2. Press **ENTER** to invert the route.

### To clear the active route from the active route page and stop route navigation:

1. Use the arrow keys to select the 'CLR?' field.
2. Press **ENTER**. Highlight the 'Yes?' prompt on the warning page and press **ENTER** to complete.

## Reviewing & Editing Routes

Once a route has been created and stored in the GPS 92, it can be edited at any time—even as an active route.

### To edit a route from the active route page or the route submenu page:

1. Use the up and down arrow keys to highlight the waypoint to edit and press **ENTER**.

An on-screen menu of editing choices will appear, with options for reviewing, inserting, removing or changing the waypoint field highlighted. Use the up and down arrow keys to select from the editing choices.

## Editing Routes

### Reviewing & Editing Routes (cont.)

With the desired waypoint field selected and the on-screen menu displayed, choose a menu function:

1. To review the available information for the waypoint, highlight the 'Review?' field and press **ENTER**.
2. To add a new waypoint that precedes the selected waypoint, highlight the 'Insert?' field and press **ENTER**.
3. To remove the selected waypoint, highlight the 'Remove?' field and press **ENTER**.
4. To replace the selected waypoint with a new waypoint, highlight the 'Change?' field and press **ENTER**.

To complete your changes, use the waypoint editing instructions described earlier (see page 26) for creating a route. If you're editing the active route (route 0), copy the new route to an empty route to save it. Otherwise, it will be overwritten by a new route activation.

If you add, delete or change the first or last waypoint of a route, the default comment (first and last waypoint) will automatically be updated after you make the changes.

### On-Route GOTOs

At the beginning of the route section, we mentioned that the GPS 92 will automatically select the route leg closest to your position as the active leg. This will give you steering guidance to the "active to" waypoint of that leg, based on the desired track of the active leg. If you would prefer to navigate directly toward another waypoint in the route, you can perform an "on-route GOTO" right from the active route page.

#### To perform an on-route GOTO:

1. Use the up and down arrow keys to highlight the desired route waypoint and press **GOTO WPT**.
2. Once the GOTO page appears, press **ENTER** to confirm the on-route GOTO waypoint.

Once you reach the GOTO waypoint, the GPS 92 will resume navigating the rest of the active route in sequence.

ACTIVE ROUTE		
H34 TO H17		
WAYPNT	ETE	DST
H34	--:--	--
H34		
H17		
----		
----		
----		
----		
----		
----		
CLR?	INV?	ACT?

Select a route edit option from the pop-up on-screen menu.

ACTIVE ROUTE		
H34 TO H17		
WAYPNT	ETE	DST
H34	--:--	--
H34	28:06	51.5
H17	01:09	126
----		
----		
----		
----		
CLR?	INV?	ACT?

To fly the active route out of sequence (or "skip ahead" to a desired starting point), simply highlight the waypoint you want to navigate to and press GOTO.

## Satellite Status Page

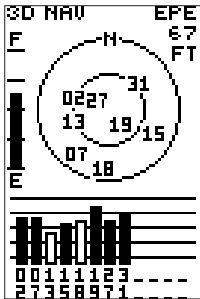

Satellites in view but not currently in use (13 and 18) will show a corresponding "hollow" signal strength bar.

### IMPORTANT!

The satellite status page displays current battery voltage. The battery level indicator is calibrated for alkaline batteries. NiCad and lithium batteries may not show battery level at full scale due to voltage differences, and will not accurately reflect current condition throughout the scale. Also, the 'Battery power is low' message may not accurately reflect current condition.

## Satellite Status Page

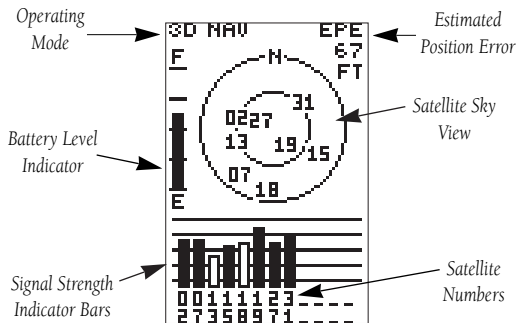

The satellite status page displays the status of various receiver functions. This status information helps you understand what the GPS is doing at any given time, and tells you whether or not the receiver has calculated a position fix.

The sky view and signal strength bars give you an indication of what satellites are visible to the receiver, whether or not they are being used to calculate a position fix, and the signal strength.

The sky view in the center of the page shows a bird's-eye view of the position of each satellite relative to the receiver's last known position. The outer circle represents the horizon (north up); the inner circle is 45° above the horizon; and the center point is a position directly overhead.

When the receiver is looking for a particular satellite, the corresponding signal strength bar will be blank and the sky view indicator will be displayed as white numbers in a black box (highlighted). Once the receiver has found the satellite, a hollow signal strength bar will appear to indicate that the satellite has been found and the receiver is collecting data from it, and the sky view indicator will display the satellite number in black numbers (not highlighted).

As soon as the GPS 92 has collected the necessary data to use the satellite for positioning, the hollow bar will become solid black.

## Satellite Status Page

### Receiver Status

Receiver status is displayed at the top left of the screen, with the current horizontal accuracy (estimated position error, in feet or meters) at the top right. The status field will show one of the following conditions:

**Searching**— the receiver is looking for any available satellites in view.

**AutoLocate**— the receiver is initializing and collecting new almanac data. This may take 3 to 5 minutes.

**Acquiring**— the receiver is collecting data from available satellites but has not collected enough data to calculate a 2D fix.

**2D Navigation**— at least three satellites with good geometry have been locked onto, and a 2-dimensional position fix (latitude and longitude) is being calculated. '2D Diff' will appear when you are receiving DGPS corrections in 2D mode.

**3D Navigation**— at least four satellites with good geometry have been locked onto and your position is now being calculated in latitude, longitude and altitude. '3D Diff' will appear when you are receiving DGPS corrections in 3D mode.

**Poor GPS Coverage**— the receiver is no longer tracking enough satellites for a 2D or 3D fix.

**Not Usable**— the receiver is unusable, possibly due to incorrect initialization or abnormal satellite conditions. Turn the unit off and back on to reset.

**Simulating Navigation**— the receiver is in simulator mode.

### EZinit Prompt

The satellite status page also displays the EZinit prompt whenever a position fix has not been calculated (the unit must be in searching, AutoLocate, acquiring, or poor coverage mode).

This prompt allows you to manually reinitialize the receiver. This feature is useful if you have traveled over 500 miles with the receiver off and you know it must be initialized to your new position (the unit will also automatically offer the EZinit prompt after 3-5 minutes of unsuccessful satellite acquisition).

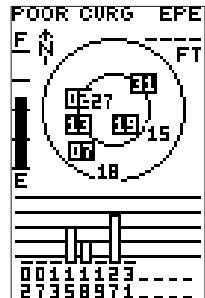

A poor coverage status will appear if the receiver has lost the number of satellites required to compute a fix.

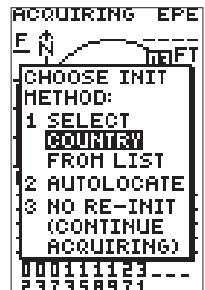

The EZinit prompt will automatically appear if the receiver needs to be initialized. The prompt may also appear during normal use if the antenna is shaded or the unit is used indoors.

## Position Page

0 NW 330 345 N
TRACK SPEED
331° 150%
TRIP ALT
15.8% 02500%
POSITION
N 29°53.246'
W097°41.719'
TIME
16:32:02

Entering an altitude manually.

0 NW 330 345 N
TRACK SPEED
331° 150%
TRIP ALT
Reset? 2477%
POSITION
N 29°57.783'
W097°44.586'
TIME
16:34:06

The trip odometer may be reset to measure distance travelled on your next trip.

## Position Page

The position page displays your current position's latitude, longitude, altitude and time. It also displays your ground track and speed whenever you're moving.

The position page lets you enter a position's latitude and longitude manually. During satellite acquisition, the position displayed is the last computed position stored in memory. To speed up the acquisition process, you can enter a more accurate initial position or reference airport (see page 7). At a minimum, be sure to accurately enter the latitude and longitude to the nearest degree.

### To manually enter a position:

1. Highlight the position field and press **ENTER**.
2. Use the arrow keys to enter the new position and press **ENTER** to confirm.

When the GPS 92 is acquiring satellites or navigating in the 2D mode, the last known altitude will be used to compute your position. You may also manually enter an altitude. Keep in mind that GPS altitude may vary significantly from pressure altimeters. Never use GPS altitude for vertical navigation.

### To enter an altitude manually:

1. Highlight the altitude field and press **ENTER**.
2. Use the arrow keys to enter the altitude and press **ENTER** to confirm.

The position page also features a resettable trip odometer to measure the total distance traveled while navigating.

### To reset the trip odometer:

1. Highlight the trip field and press **ENTER**.
2. Press the left arrow key while the highlight is on the left most character position and press **ENTER**.

The trip odometer and altitude fields may be reconfigured to display average speed (AVSPD), maximum speed (MXSPD), trip time (TTIME) or elapsed time (ELPSD).

### To change the trip odometer or altitude fields:

1. Highlight the field you wish to change and press **ENTER**.
2. Select the desired option with the up or down arrow keys and press **ENTER**.

## Map Page

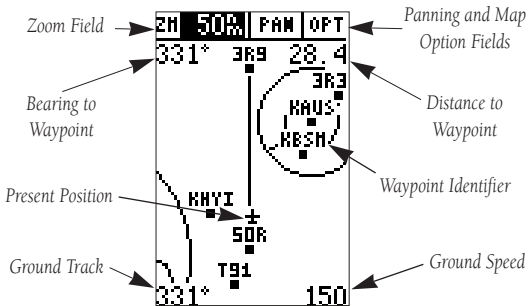

The map page plots your course and route on a moving map. It also provides you with a cursor that will let you pan ahead and review nearby waypoints, determine the distance and bearing to map position and mark new waypoints. The map page can be broken down into three sections:

The **zoom, panning control and map option fields** are all located at the top of the screen. There are 18 selectable zoom ranges from 0.2 to 500 miles (or 0.3 to 800 km), measured vertically. The pan field provides access to the map cursor, while the option field allows you to specify what items are displayed and when they appear. Track log and TracBack features are also accessed from the option field (see page 44).

The **map portion** of the page shows your movement over ground. Your present position is indicated by a plane icon (in track up mode), or a position diamond (in other modes), with your track and/or route displayed as a solid line. Nearby waypoints are represented using various icons, with the waypoint name also listed at lower scale settings. Through the map option page, you may select which features are displayed (see page 45-46).

The **data fields** located at the four corners of the map, show the bearing and distance to a destination waypoint and your current track and speed over ground. The two fields at the top corners of the map show your bearing and distance to one of three selectable destinations: an active destination waypoint, a highlighted on-screen waypoint, or the target crosshair. If you are not navigating to a waypoint or using the panning function, the top data fields will not be displayed.

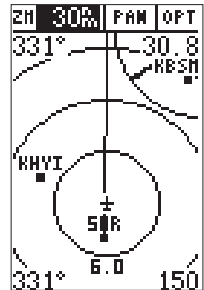

The GPS 92 has on-screen range rings to help you estimate distances relative to your present position. The value of each ring is determined by the current zoom scale. Range rings may be turned on or off through the map option menu.

## Basic Zooming & Panning

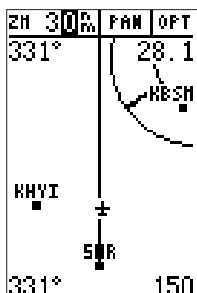

The GPS 92 offers 18 zoom scales from 0.2 to 500 nm.

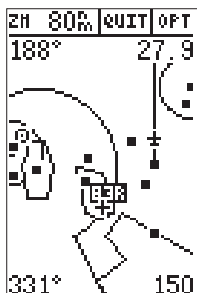

Use the panning mode to view the area surrounding your current position and nearby waypoints.

## Map Page Functions

There are four main functions you can perform from the map page—zooming, pointing, panning and map options. Each of these functions has its own “field”, which may be selected and activated for use.

Whenever the map page first appears, the zoom field (at the top left) is always selected. The map page has 18 map scales which are selected through the zoom field.

### To select a zoom scale:

1. Press the left or right arrow keys to highlight the zoom field.
2. Press **ENTER** to begin range selection.
3. Use the up or down arrow keys to scroll through and find the desired scale. Press **ENTER** to confirm your selection.

The second function field on the map page is the pan field. The pan function allows you to move the map with the arrow keys to view areas outside the current map.

### To activate the pan function:

1. From the zoom field, use the right arrow key to highlight the pan field and press **ENTER**.
2. Use the arrow keys to move the map in any direction.

As you begin to move the map, a crosshair will appear. This crosshair will serve as a target marker for the moving map. The distance and bearing to destination (at the top of the page) will now be replaced by the distance and bearing from your present position to the target crosshair.

As you pan around the moving map display, you'll notice that the target crosshair will “snap to” on-screen waypoints and highlight the waypoint name. Once a waypoint name is highlighted, you can review its waypoint definition page by using the **ENTER** key, or execute a GOTO function by using the **GOTO/MSST** key.

### To stop the panning function and return to your present position:

1. Press **QUIT**.



## Advanced Zooming & Panning

### Selecting Waypoints on Screen

From the zoom or pan fields, the cursor highlight may be moved into the map display by pressing the down arrow key. The arrow keys will now move the highlight through the map and “point” at on-screen waypoints.

#### To point at a displayed waypoint on the map:

1. Use the arrow keys to move the cursor highlight to the map field.
2. Once you are in the map field, use the arrow keys to scroll through on-screen waypoints. The arrow key you use will determine the direction you will scroll.
3. When you have scrolled through all the on-screen waypoints, the cursor will move back to the zoom, pan or option function field.
4. To return the highlight to the zoom field, press **QUIT**.

Once a waypoint has been selected in the map field, its distance and bearing from your present position will be displayed in the destination field.

### Advanced Zooming & Panning

To get the most out of the panning function, you need to be able to zoom in and out while you're panning. This lets you move the map at a faster speed and zoom in for more waypoint details. Once the pan function is activated, the cursor highlight moves back to the zoom field.

#### To adjust the zoom range while panning:

1. Press the **ENTER** key to begin zoom scale selection.
2. Use the up and down arrow keys to select the map scale. Press **ENTER** to return to normal panning mode.

During panning, the crosshair represents a target position on the map, with the range and bearing to the target displayed at the top of the screen. You can also use the target crosshair to mark a new waypoint position or as a GOTO destination right from the map field.

#### To mark the crosshair position as a new waypoint:

1. Press **WPT** to capture the position.
2. Enter a new name and route number if you wish and press **ENTER** to return to the map page.

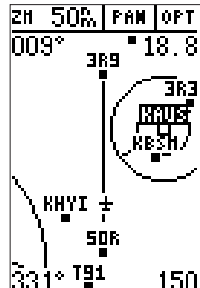

To highlight an on-screen waypoint, simply place the cursor on top of the waypoint. A black box will appear around the waypoint with the name shown in white letters.

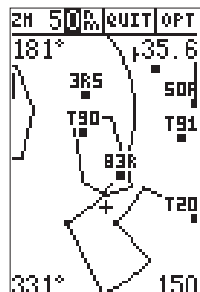

While panning, you may change the zoom scale without having to switch from panning mode to zoom mode.

## Map Waypoints & Map Options

### GO TO:

MAP----

-PRESS ENTER  
TO ACTIVATE  
NAVIGATION

-PRESS GOTO TO  
SEE NEAREST  
WAYPOINTS OR

Be sure to rename the 'MAP' waypoint if you want to save it, as it will be overwritten when you perform your next GOTO.



Map Option Menu

You may custom tailor the map to your needs by selecting from a variety of changeable options which are controlled from the map option menu.

You can also use the target crosshair as an instant GOTO destination. This function will AutoStore the position and set a course for a new waypoint called 'MAP'.

### To GOTO the target crosshair:

1. Press **GOTO** **NRST** to capture the position.
2. Press **ENTER** to confirm the 'MAP' waypoint GOTO.
3. Press **QUIT** to return to the map page.

In saving the 'MAP' waypoint, be sure to rename it, as it will be overwritten the next time a map GOTO is executed.

### Map Options

The last function you can perform from the map page is map options, which lets you select what features are displayed on the map, set the map orientation and manage the track log functions.

### To access the map option function:

1. Highlight the 'OPT' field on the map page and press **ENTER**.

The map option menu will appear, listing the following options: map setup, waypoints, airspace and track log.

### Map Orientation, Range Rings, and Track Log

The map option menu's 'MAP SETUP' lets you turn AutoZoom (see page 45), track log and range ring features on or off and define a map orientation. The 'MAP' field lets you set the map to a north up, track up (the direction of current travel) or a desired track up (the direction of an active route leg) orientation.

The 'RINGS' field enables the on-screen range rings, which help you estimate the distance to items depicted on the map. The distance defined by each ring is determined by the current zoom scale. The 'ROUTE' field allows you to display a solid course line connecting each point along your route (or a single course line in the case of a GOTO). The 'TRACK LOG' field turns display of track log data on or off.

### To set orientation, range rings, route line or track log:

1. Highlight the desired map display field setting and press **ENTER**.
2. Use the up and down arrow keys to select the desired setting, and press **ENTER**.

## AutoZoom

AutoZoom automatically changes the map scale to keep your present position and destination on the display at all times. Whenever a GOTO or route is activated, AutoZoom will default to the largest map scale that will fit your present position and 'active to' waypoint (up to the 50 nm scale). As you head toward the destination, the scale will change to the next lower scale when your present position and the destination can be displayed on that particular scale.

The AutoZoom feature will stop when the scale has reached the 1.2 nm setting. AutoZoom is designed to allow you to manually change the map scale without turning the automatic map scaling off. In addition, AutoZoom determines whether or not to change the scale based upon the current status of the map:

- If the map scale is manually zoomed in before an AutoZoom takes place, the automatic scaling will resume once it reaches the scale you have selected.
- If the map scale is manually changed to a setting higher than the current AutoZoom setting, automatic map scaling will be cancelled unless the map scale is manually returned to the current or smaller AutoZoom setting.
- If the zoom field is active (it has been highlighted and the **ENTER** key has been pressed) when the map is ready to scale down to the next level, the AutoZoom feature will be cancelled.

The AutoZoom feature can be turned off through the map option menu described on page 44.

## Waypoint Category Viewing Scale

The map options menu's 'WAYPOINTS' selection allows you to define what waypoint types and text are displayed on the map and the scales in which they will appear. The categories on the setup page are: APT, INT, NDB, VOR, User and Ident(ifier). The scale field to the right of each category lets you designate a maximum map scale at which the item will appear or allow you to turn the category off altogether. Each category has 19 adjustable settings, from 0.2 nm to 500 nm and 'OFF'.

## Map Options: AutoZoom & Waypoints

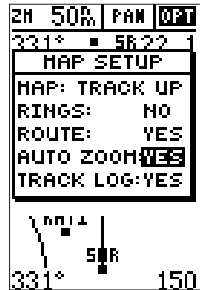

AutoZoom automatically uses the largest scale which will show your current position and the destination waypoint.

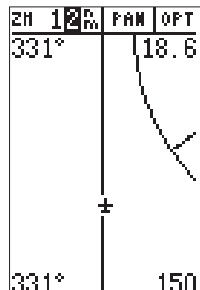

Using the AutoZoom function will allow manual map scale changes without turning automatic map scaling off.

## Map Options: Airspace & Track Log



ZH	30M	FAN	OPT
AIRSPACE			
CLASS	E/CTA:	500M	
CLASS	C/TMA:	500M	
OTHER	CTRL:	20M	
OTHER	SUA:	500M	
MOA:		500M	
Restrict:		500M	

The map airspace setup page allows you to designate a minimum map scale or to turn off a selected airspace category entirely.

Settings are available for the following airspace categories:

- Class B / CTA
- Class C / TMA
- Other controlled airspace
- Other special-use airspace
- Military Operations Area (MOA)
- Restricted Area



### To change the viewing scale for a waypoint category:

1. Highlight the scale for the desired category and press .
2. Use the up and down arrow keys to select the desired setting, and press  to confirm.

### Map Airspace Options

The next listing on the map option menu is 'AIRSPACE', which allows you to designate a minimum map scale at which an airspace will be depicted or allows you to turn off the selected airspace category entirely. Each category has 19 adjustable settings, from 0.2 nm to 500 nm and 'OFF'. The 'OTHER SUA' airspace category includes alert, caution, danger, warning, and training areas. The 'OTHER CTRL' category includes control zones (Europe) and control tower areas (typically Class D) which are within five nautical miles around an airport with a control tower and up to 2,500 feet above airport elevation. Prohibited airspaces are not selectable and will always be displayed. Turning off an airspace from the map options menu simply removes it from the map display and **DOES NOT** turn off the alert messages for that airspace category. For more information on SUAs and alert messages, see page 59.

### To change the viewing scale for an airspace category:



1. Highlight the scale for the desired category and press .
2. Use the up and down arrow keys to select the desired setting, and press .

### Track Log Options

At the bottom of the map option menu is the 'TRACK LOG' selection. The corresponding track setup page lets you manage and erase the GPS 92s track log data. (A track log is merely an electronic 'breadcrumb trail' recording of your path, showing where you've been.) From the track setup page, you can select whether or not to record a track and define how it is recorded.

The 'RECORD' option lets you select one of three recording options: 'OFF', 'FILL' or 'WRAP'. The 'FILL' option will record track log data until the maximum memory of 2048 points is reached, then stop and provide a "Track memory full" message. The 'WRAP' option will continuously record track log data by wrapping through available memory and replacing the oldest track data with new data.

**To select a record option:**





1. Highlight the 'RECORD' field and press .
2. Select the desired option with the arrow keys and press .



**NOTE:** Turning the track recording off will also disable the TracBack feature, since no data will be recorded from which to build the TracBack route.



The track method (or criteria) determines how often positions are stored in the track log. The default setting is 'AUTO'. This setting uses a "resolution" method (or variance from your course over ground), gives you the most efficient use of track memory and provides the most accurate TracBack route. A 'TIME INTERVAL' option is also available to record track log data based upon a user-defined setting.

**To change the method used to record points:**

1. Highlight the 'RECORD' field and press .
2. Select the desired method and press .
3. If 'TIME INTERVAL' is selected: press , enter a value in hours, minutes and seconds and press .

The rest of the track log setup page displays the percentage of memory used to store the current track log data and contains function fields used to clear the track log memory and activate the TracBack feature.

**To clear the track log:**

1. Highlight 'CLEAR LOG?' and press .
2. A warning page will appear, asking you to confirm your actions. Highlight 'Yes?' and press .

**TracBack Function**

The last option on the track setup page is the TracBack function which lets you activate a TracBack route using the track log. (See pages 31-32 for more information.)

**To activate a TracBack route:**

1. Highlight 'TRACBACK?' and press .

## Map Options: Track Log & TracBack

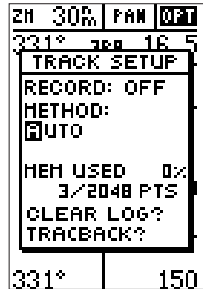

The 'METHOD' setting allows you to record track log data based upon an 'AUTO' option or a time interval. Use 'AUTO' for best TracBack performance.

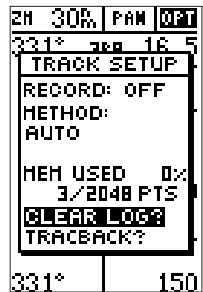

To clear track log memory, select the 'CLEAR LOG?' option. Use the 'TRACBACK?' option to create a TracBack route.

# Navigation Page

## Navigation Page

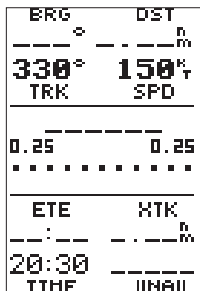
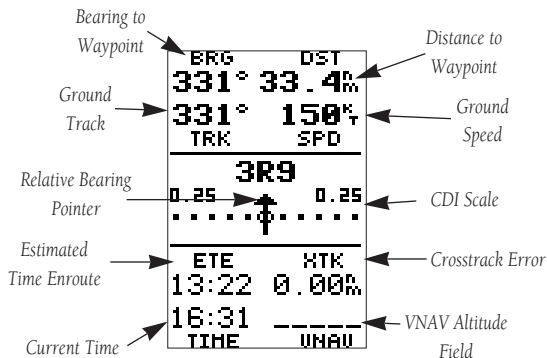

If the GPS 92 is not navigating to a destination waypoint, the navigation page will only display your speed and track over ground.

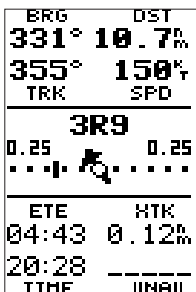

If the relative bearing pointer points any direction other than straight up, turn toward the arrow until it swings around and points up. Then continue in that direction to reach your destination.

The navigation page displays the bearing (BRG) and distance (DST) to the destination at the top of the page, along with your present speed (SPD) and ground track (TRK). The GOTO destination (or “active to” waypoint in the case of a route) is displayed on the middle of the page, above the course deviation indicator (CDI).

The CDI consists of a course deviation scale across the center of the page and a moving D-bar (course deviation bar). If you move off course, the D-bar will indicate how far off course you are, based upon its placement along the course deviation scale. To get back on course and center the D-bar, simply steer toward the D-bar. The CDI scale is adjustable for 0.25, 1.25 or 5.0 (nautical mile/statute mile/kilometer). The default setting is 1.25, which represents the distance from the center of the CDI to full left or right limits. (See page 51 for more information on CDI scale settings.)

A relative bearing pointer—which remains fixed at the center of the CDI scale—points in the direction of your destination, relative to your current ground track. For instance, if the arrow points up you are heading directly to your destination. If the arrow points any other direction, turn toward the arrow until it “swings” around and points up. Then continue in that direction to reach your destination.

At the bottom of the page appears your estimated time enroute (ETE), cross track error (XTK) and current time (local or GMT, see page 52). The vertical navigation (VNAV) field is user-definable and may be used to guide you through climbs or descents to a specified target altitude (see page 64).

## Main Menu Page

The GPS 92's main menu page provides access to sub-menus and functions that are used to select and customize operation and navigation setup. The listings are divided into categories by function. The route management features are discussed on pages 33-37.

## Main Menu Page

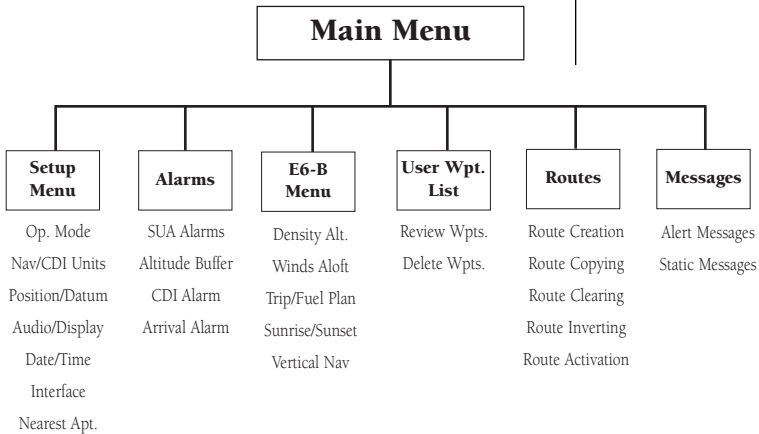

### To select a submenu from the main menu page:

1. Highlight the desired menu option/function.
2. Press **ENTER** to display the submenu/function page.
3. To return to the main menu page, press **QUIT**.

The first listing on the main menu page is the setup menu option, which provides access to the setup submenu, where you can select operating modes, display, and other settings to meet your specific preferences. To select a setup option from the setup menu, simply highlight the desired listing and press **ENTER**.



### Setup Menu Option

## Setup Menu: Operation Mode & Initial Position

OPERATION
Current Mode: [X] Simulator?
Initial Position Ref: 50R Brg: 331° Dis: 2.3%

Selecting simulator mode.

OPERATION
Current Mode: Simulator
Initial Position Ref: [X] 0R____ Brg: 331° Dis: 2.3%

To speed up calculation of the initial position, you may reference an existing waypoint.

## Operation Mode Page

The first setup page is the 'Operation' mode page, which is used to select the operating mode and set an initial position reference for initialization or simulator use.

The GPS 92 features two operating modes:

- **Normal** operates the unit at maximum performance, and provides battery life of up to 24 hours.
- **Simulator** allows you to operate the unit without acquiring satellites, and is ideal for practicing or entering waypoints and routes while at home.

### To select an operating mode:

1. Highlight the 'Current Mode' field and press **ENTER**.
2. Use the arrow keypad to choose a mode and press **ENTER**.
3. The 'Ref' field will then be highlighted to enable entry of a reference waypoint, if desired. Press **QUIT** to finish.

## Initial Position Entry

The initial position field allows you to define a starting point for simulated trips or name an initial position to speed up the acquisition process if the unit has moved more than 500 miles with the power off. When the unit is in simulator mode, you may select a known waypoint as your starting position, or define a distance and bearing from a known waypoint to calculate your starting latitude and longitude.

When the unit is in normal mode, the bearing and distance fields will not be available. Keep in mind that while entering an initial position may speed up acquisition, entering an incorrect initial position will have an adverse effect on the receiver's ability to find the necessary satellites to calculate an accurate position.

### To enter an initial position reference:

1. Highlight the 'Ref' field.
2. Enter the identifier of the reference position waypoint and press **ENTER**.



## Setup Menu: Nav Units & CDI Scale

If the unit is in simulator mode, the field highlight will advance to the 'Brg' field, where you may define your position in reference from the selected waypoint.

### To enter a bearing from the reference waypoint:

1. With the field highlight on the 'Brg' field, enter a bearing and press **ENTER**.

### To enter a distance from the reference waypoint:

1. With the field highlight on the 'Dis' field use the alphanumeric keys to enter a distance and press **ENTER**.

To exit the operation mode submenu and return to the setup menu press **QUIT**.

## Navigation Units

The next setup menu listing is 'Nav Units', where you may select from statute, metric, or nautical navigation units for all speed, distance, altitude, temperature and barometric pressure fields.

### To select navigation units :

1. Highlight the desired field and press **ENTER**.
2. Use the arrow keypad to choose the desired units and press **ENTER**.

## CDI Scale

The CDI scale field lets you select the +/- range of the course deviation scale that appears on the nav page. Three scales are available: +/- 0.25, 1.25 and 5.0 (miles or kilometers), with 0.25 being the default setting.

### To select a CDI scale:

1. Highlight the 'SCALE' field and press **ENTER**.
2. Use the arrow keypad to select a scale and press **ENTER**.

## Heading Display

Heading information is also displayed on the nav unit submenu. Heading information can be displayed referencing magnetic north (automatic or user-defined), true north or calculated grid headings. The default setting is an automatically-calculated magnetic north ('AUTO'), which is suitable for most applications.

NAV UNITS
DIST/SPEED: NM/KNOTS
ALTITUDE: FEET
CDI SCALE: 0.25
TEMPERATURE: FAHRENHEIT
BARO PRESS: MERCURY
HEADING: USER: E000

Nav Units

NAV UNITS
DIST/SPEED: NM/KNOTS
ALTITUDE: FEET
CDI SCALE: 1.25
TEMPERATURE: FAHRENHEIT
BARO PRESS: MERCURY
HEADING: USER: E000

CDI scale settings of 0.25, 1.25 and 5.0 (nautical miles/statute miles or kilometers) are available.

## Setup Menu: Heading Reference & Map Datum

NAV UNITS
DIST/SPEED: NM/KNOTS
ALTITUDE: FEET
CDI SCALE: ±1.25
TEMPERATURE: FAHRENHEIT
BARO PRESS: MERCURY
HEADING: AUTO E006

Heading Reference

POSITION
Posn Format: hddd°mm.mmm'
Map Datum: WGS 84

**WARNING:** Using the wrong map datum can result in substantial position errors.

### To select a heading reference:

1. Highlight the 'HEADING' field and press **ENTER**.
2. Select a heading reference and press **ENTER**.

### To enter a user-defined magnetic heading:

1. Select the 'USER MAG' heading and press **ENTER**.
2. Enter the direction ('E' or 'W') and degrees of magnetic variation and press **ENTER** to confirm.

### Position Format

The next setup menu listing is 'Position/Datum'. The default position setting is latitude and longitude in degrees and minutes (hddd°mm.mmm'). You may also select degrees, minutes and seconds (hddd°mm'ss.s'); degrees only (hddd.dddd°); UTM/UPS coordinates; or West Malayan, Taiwan, Swiss, Swedish, Irish, Indian, German, British, MGRS or Maidenhead grid formats.

### To select a position format:

1. Highlight the 'Posn Format' field and press **ENTER**.
2. Select a format and press **ENTER**.

### Map Datum Setting

The map datum is located just below the heading field. The default setting is 'WGS 84'. Although over 100 map datums are available for use (see the map datum list in Appendix D), you should only change the datum if you are using charts which specify a datum other than WGS 84.

### To select a map datum:



1. Highlight the 'Map Datum' field and press **ENTER**.
2. Use the arrow keypad to toggle through and select the desired setting. Confirm the setting by pressing **ENTER**.

## Setup Menu: Audio/Display & Date/Time

### Audio/Display Options



The 'Audio/Display' options allow the user to adjust the display contrast of the display screen, set the backlight timer and turn the alarm/keypress tone generator on or off.

#### To set the screen contrast:

1. Highlight the 'Contrast' field and press .
2. Use the right and left arrow keys to adjust the bar scale for the desired contrast and press .



The backlight timer provides six different adjustable settings to choose from: 0, 15, 30, 60, 120 and 240 seconds. The '0' setting will prevent the screen backlight from "timing out"—so when you turn it on, it stays on.

#### To set the backlight timer:

1. Highlight the 'Backlight Time' field and press .
2. Toggle through and select the desired setting. Confirm the setting by pressing .
3. To turn backlighting on and off through three levels of lighting, press the  key.

The 'Tones' setting allows you to select from three options: MSG only, MSG and Keystroke, and None. This determines if an audible tone sounds for message alerts and/or keystroke confirmation, or not at all.



#### To select a tone mode:

1. Highlight the 'Tones' field and press .
2. Select the desired tone mode and press .

### Date/Time and Timer Options

The 'Date/Time' submenu provides access to time format, local time offset and timer functions. The current date and time is displayed at the top page. The time can be displayed in a 12- or 24-hour format.

#### To set the hour format:

1. Highlight the 'HOUR FORMAT' field and press .
2. Use the arrow keypad to toggle through and select the desired setting. Confirm the setting by pressing .



*Contrast, backlight timer, and tone may be controlled from the audio/display page.*

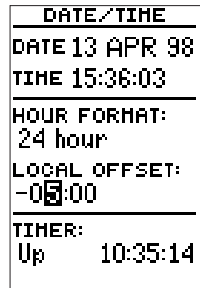

*Date/Time setup page*

## Setup Menu: Date/Time & Timers

DATE/TIME
DATE 13 APR 98
TIME 15:38:28
HOUR FORMAT: 24 hour
LOCAL OFFSET: -05:00
TIMER: Up 00:00:00

To reset the timer, highlight the 'Timer:' field and press the LEFT ARROW key.

DATE/TIME
DATE 13 APR 98
TIME 15:38:01
HOUR FORMAT: 24 hour
LOCAL OFFSET: -05:00
TIMER: Down 00:00:00

Setting the count down timer.

## Date/Time and Timer Options

The date and time are calculated from satellites and cannot be edited. Because the time shown is UTC (GMT or 'zulu') time, you will need to enter a time offset to display the correct local time for your area.

### To enter the time offset:

1. Highlight the 'LOCAL OFFSET' field.
2. Enter the time offset for your longitude and press **ENTER**. Remember to select a positive or negative indicator for your offset. (You'll have to move the field highlight to the left of the offset to enter a positive or negative sign for the offset. A negative sign is used for North America.)
3. Press **ENTER** to confirm the offset.

The GPS 92's timer function will count *down* from an entered interval and alert you with a message, or use it as an elapsed timer that will count *up* to 99:59:59.

### To set the countdown timer:

1. Highlight the 'Timer' field and press **ENTER**.
2. Select the 'Down' setting and press **ENTER**. The highlight will advance to the time field.
3. Enter the countdown time (hours, minutes and seconds).
4. Press **ENTER** to confirm and begin the countdown.

When the timer expires (at 00:00:00), you will be informed with a "Timer has expired" message.

The timer will also automatically transition to the count up mode and display how much time has elapsed since the timer expired. The count up timer will keep a running clock until it is manually reset.

### To reset the count up timer:

1. With the 'Timer' field in the count 'Up' setting, highlight the timer field and press **ENTER**.
2. Press the left arrow key to clear the field. Press **ENTER** to finish and restart the timer.

## Setup Menu: Interface

### Interface Setup

The 'Interface' setup page lets you specify the interfacing formats for connecting external NMEA devices, a DGPS receiver, or a personal computer. The input/output format field, at the top of the page, lets you specify one of six formats (input first followed by output):

- **'GRMN/GRMN'** is a proprietary interface that allows you to exchange data such as waypoints, routes and track logs with another GPS 92 or with a personal computer using a GARMIN PC kit.
- **'NONE/NMEA?'** provides navigation information to a compatible NMEA device such as a PC-based moving map program, an ARGUS display or radar display. NMEA 0180, 0182, 0183 v. 1.5 and 0183 v. 2.0 output options are available.
- **'NMEA/NMEA?'** allows input from a NMEA compatible device, with selectable NMEA output.
- **'RTCM/NMEA?'** allows DGPS beacon receiver input and also provides selectable NMEA output.
- **'RTCM/NONE?'** allows DGPS beacon receiver input without output capabilities.
- **'NONE/NONE?'** provides no interfacing capabilities.

#### To select an I/O format:

1. Highlight the I/O field and press **ENTER**. Toggle through and select the desired setting, and press **ENTER**.

The 'GRMN/GRMN' setting is a proprietary format that lets you exchange user data between GARMIN GPS units or a PC with an optional GARMIN PC kit. During data transfer, the number of packets being exchanged will be displayed on screen. Besides the 'Host' setting—which allows a PC or second GPS unit to control I/O functions—settings to request ('RQST') or send almanac, waypoint, track log and route data are also provided.

#### To select a transfer option:

1. Highlight the 'Host' field and press **ENTER**.
2. Select the desired setting and press **ENTER**.

To disable all GPS 92 interfacing capabilities, select the 'NONE/NONE' setting. If you want to output NMEA data to compatible external devices without any differential input capability, select the 'NONE/NMEA' setting.



Highlight the I/O field and press **ENTER** to select an option. For NMEA output, 0183 version 2.0 with a baud rate of 4800 is the default selection.

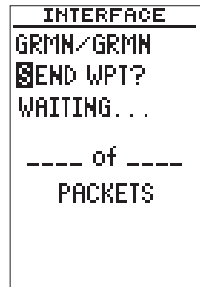

Selecting a transfer option.

## Setup Menu: DGPS Interface Setup

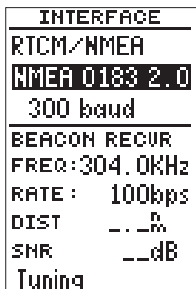

### DGPS Interface

Once the 'RTCM/NMEA' interface option is selected, you must tune the beacon receiver from the frequency field.

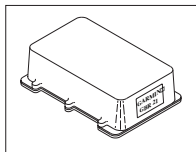

DGPS corrections are accepted in RTCM-104 v. 2.0 format. The GARMIN GBR 21 is the recommended beacon receiver for use with the GPS 92. Other receivers with the correct RTCM format may be used, but may not correctly display status or allow tuning control directly from the GPS 92.

When a NMEA output setting has been selected, a baud rate of 4800 will automatically appear.

### To select a different baud rate:

1. Highlight the baud rate field and press **ENTER**.
2. Select the desired setting and press **ENTER**.

### DGPS Interface Setup

The two RTCM settings allow the GPS 92 to accept Differential GPS (DGPS) corrections in RTCM 104 version 2.0 format. The 'RTCM/NONE' format allows you to connect any manually-tuned beacon receiver with the proper interface. The baud rate is selectable from the GPS 92. The 'RTCM/NMEA' selection allows you to control a GARMIN GBR 21 beacon receiver directly from the GPS 92.

Once an RTCM setting has been selected, the GPS 92 will automatically try to tune the last frequency and bit rate selected, or it will switch to the default frequency of 304.0 kHz with a bit rate of 100 bps if no previous beacon has been tuned. You may also enter your own frequency and bit rate if desired.

### To enter a beacon frequency and bit rate:

1. Highlight the 'FREQ' field and press **ENTER**.
2. Enter the desired frequency and press **ENTER**.
3. Highlight the 'RATE' field and press **ENTER**.
4. Select the rate and press **ENTER**.

When the GPS 92 is receiving DGPS corrections, the 'BEACON RECVR' section of the interface page will display the signal strength and distance from the transmitter to the beacon receiver. A status message will constantly keep you informed of DGPS activity:

- A 'Tuning' message will be displayed while a beacon signal is being tuned. Once the signal has been tuned, the message 'Receiving' will be displayed.
- If a signal is tuned and no corrections are being received, a 'No Data' message will be displayed.
- If a beacon signal cannot be tuned, a 'No Status' message will be displayed.

## Updating the GPS 92's Database



The GPS 92's internal worldwide Jeppesen database may be updated from a PC computer using GARMIN's optional PC Database Update Software and an interface cable. Updates are available—every 28 days—from Jeppesen or GARMIN on a subscription or one time basis. Update instructions are provided with each update software package. When performing a database update, select the 'GRMN/GRMN' setting on the interface setup page.

### Nearest Airports

The last listing on the setup menu is 'Nearest Apt', which allows you to define the surface type and minimum runway length used to calculate the nearest airports. The options for runway surfaces are:



- **Any:** (Default setting) any runway, regardless of surface type, including water landing facilities.
- **Hard Only:** Only runways with a concrete, asphalt or similar sealed surface.
- **Hard or Soft:** All runways except water landing.
- **Water Only:** Only water landing facilities.

#### **To select a runway surface:**

1. Highlight the runway surface field and press .
2. Select the desired surface type and press .

The nearest airport page allows you to designate a minimum runway length used to determine the nine nearest airports. The default setting is zero feet.

#### **To enter a minimum runway length:**

1. Highlight the 'Minimum Length' field and press .
2. Enter the desired runway length and press .

## Setup Menu: Nearest Airports



AMERICAS  
CYCLE  
9804  
EFFECTIVE  
26 MAR 98  
TO  
23 APR 98

After a database update is completed, the GPS 92 will automatically display the database page, showing the effective date of the new database.

### NEAREST APT

Runway  
Surface:  
Any

Minimum  
Length:  
2000'

Selecting a minimum runway length.

## Main Menu: Alarms

### Alarm Functions

The second option available on the GPS 92's main menu page is the 'Alarms' submenu, which is used to control airspace alarms, or set arrival and CDI alarms.

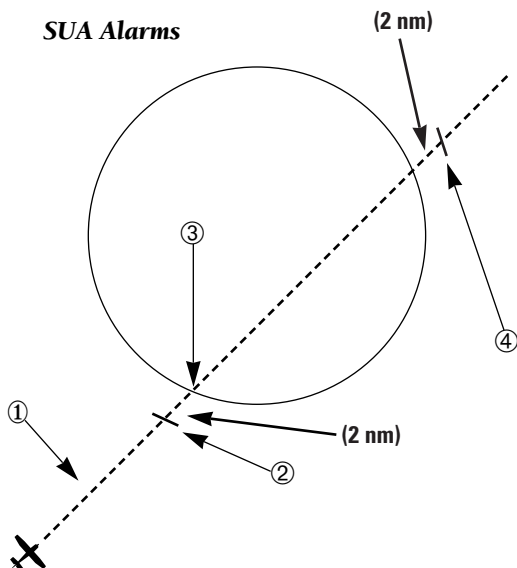

### SUA Alarms

The GPS 92's special-use airspace (SUA) features will inform you if any special-use or controlled airspace is near or in your flight path, according to the following conditions:

- ① If your projected course will take you inside an SUA within the next 10 minutes, an **'SUA ahead < 10 min'** message will be displayed.
- ② If you are within 2 nm of an SUA and your current course will take you inside, an **'SUA near & ahead'** message will be displayed.
- ③ If you have entered an SUA, an **'Inside SUA'** message will be displayed.



- ④ If you are within 2 nm of an SUA and your current course will not take you inside the airspace, a 'Near SUA < 2nm' will be displayed.



**NOTE:** All SUA alerts are based on your present GPS altitude. Some airspace altitude limits may be charted in terms of altitude above ground level (AGL). If the actual lower limit of an airspace is charted in AGL, the GPS 92 will alert you at any altitude below the upper limit. However, if the actual upper limit is also charted in AGL, the GPS 92 will provide the alert at all altitudes.



The GPS 92's provides SUA alarms for the following airspace types:

- Class B/CTA- ICAO Control Area
- Class C/TMA- ICAO Terminal Control Area
- Other CTRL- Other Controlled Airspaces such as control tower airspace and control zones. (Typically referred to as Class D.)
- MOA- Military Operations Area
- Restricted- Restricted areas
- Other SUA- Other airspaces, including alert, caution, danger and warning areas

### **Turning SUA Alarms On & Off**

Turning a warning 'off' from the alarms page will only prevent you from receiving a message alert for an airspace. SUA information will still be displayed on the map page unless that category is turned off from the map option menu (see page 44).

#### **To turn an SUA alarm category on or off:**

1. Highlight the desired SUA category and press .
2. Select 'On' or 'Off'.
3. Press .



**NOTE:** Alarms for prohibited areas are always on. Disabling any of the above listed airspace categories only removes the alert. The boundaries will still appear on the map display, unless disable from the map options page.

## Main Menu: Alarms

ALARMS	
CLS B/CTA:	ON
CLS C/TMA:	ON
OTHER CTRL:	ON
MOA:	<input type="checkbox"/> OFF
RESTRICT:	ON
OTHER SUA:	ON
<hr/>	
ALT BUF:	200%
<hr/>	
CDI ALARM:	OFF
	0.0%
<hr/>	
ARRIVAL:	AUTO

*Turning an SUA alarm category off.*

## Main Menu: Alarms

ALARMS	
CLS B/CTA:	ON
CLS C/THA:	ON
OTHER CTRL:	ON
MOA:	ON
RESTRICT:	ON
OTHER SUA:	ON
ALT BUF:	0000%
CDI ALARM:	OFF
	0.0%
ARRIVAL:	AUTO

Setting an altitude buffer.

ALARMS	
CLS B/CTA:	ON
CLS C/THA:	ON
OTHER CTRL:	ON
MOA:	ON
RESTRICT:	ON
OTHER SUA:	ON
ALT BUF:	200%
CDI ALARM:	ON
	02.0%
ARRIVAL:	AUTO

The CDI alarm will alert you if you are off course by more than the selected limit.

## Altitude Buffer

The 'ALT BUF' field, located directly below the SUA alarm settings, is an altitude buffer that allows you to set a specific altitude range for triggering SUA alerts. This helps add an extra margin of safety to your estimated altitude error to ensure you receive SUA messages in time to avoid unwanted SUA intrusions. The default altitude buffer setting is 200 feet.

The value of the altitude buffer is added to an estimated altitude error calculated by the GPS 92. This value is then added or subtracted from your present GPS altitude. If the final adjusted altitude falls within an SUA, you'll receive a message. If the adjusted altitude does not place you in an SUA, you won't receive the message.

### To enter an altitude buffer:

1. Highlight the 'ALT BUF' field and press **ENTER**.
2. Enter a buffer value and press **ENTER**.



**NOTE:** If you fly above or below an airspace, then descend or climb to enter the airspace, the 'Inside Airspace' message may be the only alert provided! The 'Airspace Ahead' and/or 'Airspace Near' messages will not occur if you are outside the vertical limits defined by the airspace, plus the altitude buffer.

## CDI Alarm

The next section of the alarms page allows you to set a CDI/crosstrack alarm, which defines a maximum allowable left/right off course error. The CDI alarm will provide a message when your crosstrack error exceeds the specified distance.

### To set the CDI alarm:

1. Highlight the 'CDI ALARM' field and press **ENTER**.
2. Select 'ON' and press **ENTER**.
3. Press **ENTER** to select the distance field, enter a distance (up to 99.9 nm) and press **ENTER**.

## Main Menu: Alarms & E6-B

### Arrival Alarms

The last function available from the alarms page is the waypoint arrival alarm, which will activate an alarm message once you've come within a set distance of a destination waypoint. Three options are available:

**Off-** No arrival alarm will sound.

**Auto-** An arrival alarm will sound one minute before the destination—or each waypoint in a route—based upon your current ground speed and ground track.

**On-** An arrival alarm will sound at the alarm distance specified in the distance field for the destination waypoint.

(The 'On' setting will only provide an arrival alarm for the final destination waypoint of an active route).

#### To set the arrival alarm:

1. Highlight the 'Arrival' field and press **ENTER**.
2. Use the arrow keys to select 'On', 'Off', or 'Auto' and press **ENTER**.
3. Press **ENTER** to select the arrival distance field.
4. Enter a distance (up to 99.9 nm) and press **ENTER**.

### E6-B Menu

The third listing on the main menu page is the 'E6-B Menu', which provides access to the GPS 92's density altitude and winds aloft functions. The E6-B menu also allows access to trip and fuel planning, sunrise and sunset calculations, and vertical navigation profiles.

#### To calculate density altitude and true air speed:

1. Select 'Density Alt' from the E6-B menu and press **ENTER**.
2. Highlight the 'IAlt' field and press **ENTER**.
3. Enter the indicated altitude from your altimeter and press **ENTER**. The highlight will move to the 'CAS' field.
4. Press **ENTER**. Enter the calibrated airspeed and press **ENTER**. The highlight will move to the 'Prs' field.
5. Press **ENTER**. Enter your current altimeter setting and press **ENTER**. The highlight will move to the 'TAT' field.
6. Press **ENTER**. Enter the TAT (reading from standard outside air temperature gauge on most piston aircraft) and press **ENTER**. The calculated density altitude and true air-speed will be displayed at the bottom of the page.

ALARMS	
CLS B/CTA:	ON
CLS C/THA:	ON
OTHER CTRL:	ON
MOA:	ON
RESTRICT:	ON
OTHER SUA:	ON
<hr/>	
ALT BUF:	200%
CDI ALARM:	OFF
	0.0%
<hr/>	
ARRIVAL:	ON
	10.0%

The arrival alarm can be used to notify you when you have reached a set distance from a destination waypoint.

MAIN MENU
Setup Menu
Alarms
<b>E6-B Menu</b>
User Wpt List
Routes
Messages

Highlight 'E6-B Menu' and press **ENTER** to access navigation utilities such as winds aloft and true air-speed calculations, trip and fuel planning and vertical navigation profiles.

## Main Menu: E6-B

WINDS ALOFT	
TAS:	156%
Hdg:	344°
Head Wnd 6.0%	
Wind from 277°	
at 28%	

Winds aloft may be calculated by entering your true air speed and current heading.

TRIP AND FUEL	
<b>Waypoint</b>	
From:	KCOS
To:	KSLC
Speed:	150%
Flow:	12
DTK	282°
DIS	357%
REQ	29
ETE	02:23

Navigational information and fuel usage may be calculated for a trip between any two waypoints.

## Winds Aloft Function

The GPS 92's winds aloft function will calculate the wind direction, speed and head/tail wind conditions for the aircraft once you have entered your true air speed and current heading.

### To calculate winds aloft:

1. Select 'Winds Aloft' on the E6-B menu and press **ENTER**.
2. Highlight the true airspeed ('TAS') field and press **ENTER**.
3. Enter the TAS (if you've already calculated TAS using the density altitude function it will be offered here) and press **ENTER**.
4. Press **ENTER** to begin entry of your current heading (Hdg).
5. Enter your heading and press **ENTER**. The wind direction, speed and the head/tail wind conditions will be displayed at the bottom of the page.

## Trip and Fuel Planning Function

The GPS 92's trip and fuel planning function will calculate the desired track, distance, estimated time enroute and fuel requirements between any two waypoints or any programmed route. The first field (top left of the planning page) allows you to select between waypoint or route planning.

### To perform a waypoint-to-waypoint trip and fuel plan:

1. Select 'Trip & Fuel' on the E6-B menu and press **ENTER**.
2. Highlight the Waypoint/Rte field and press **ENTER**.
3. Select the 'Waypoint' option and press **ENTER**. The field highlight will move to the 'From' field. Press **ENTER**.
4. Enter the starting waypoint for the trip (or leave the field blank to start from your present position) and press **ENTER**. The field highlight will advance to the 'To' field.
5. Press **ENTER**. Enter the destination waypoint and press **ENTER**. The field highlight will advance to 'Speed'.
6. Press **ENTER**. Enter trip speed and press **ENTER**. The field highlight will advance to the 'Flow' field.
7. Press **ENTER**. Enter the fuel flow for the trip and press **ENTER**. The desired track (DTK), distance (DIS), fuel requirement (REQ), and estimated time enroute (ETE) of the trip will be displayed at the bottom of the page.

## Route Planning

The route planning function will calculate trip information for any programmed route and provide data on both the entire route and each individual route leg.

### To perform a route trip and fuel plan:

1. Highlight the Waypoint/Rte field and press **ENTER**.
2. Select the 'Rte' option and press **ENTER**. The field highlight will move to the route number field.
3. Press **ENTER** to begin selection of the desired route.
4. Enter the route number and press **ENTER**. The field highlight will advance to the 'Leg' field. Press **ENTER**, select either 'All' or a specific route leg (Leg 1, etc.) to calculate, and press **ENTER**.
5. Enter the route or leg speed and press **ENTER**. The field highlight will advance to the 'Flow' field.
6. Enter the fuel flow for the route or leg and press **ENTER**.

The GPS 92 will display the distance, fuel requirement and estimated time enroute for the route or route leg, and provide the desired track for each leg.

## Sunrise/Sunset Calculator

The next E6-B function available is the sunrise/sunset calculator, which will allow you to calculate the sunrise and sunset for any known waypoint or your present position for any specified date.

### To calculate sunrise/sunset information:

1. Select 'Sunrise/Sunset' on the E6-B menu and press **ENTER**.
2. Highlight the waypoint field and press **ENTER**.
3. Enter the desired waypoint (or leave the waypoint field blank to calculate the sunrise/sunset for your present position) and press **ENTER**. The field highlight will automatically advance to the date field. Press **ENTER**.
4. Enter the day of the month, 3-letter month abbreviation, and the two-digit year abbreviation. The default date will be the current date as calculated by the GPS satellites.
5. Press **ENTER**. The sunrise and sunset for the entered date will be displayed at the bottom of the page.

## Main Menu: E6-B

TRIP AND FUEL	
Rte	2 Leg 1
From:	K34
To:	9K4
Speed:	110%
Flow:	10
DTK	087*
DIS	54.1%
REQ	5
ETE	29:31

*If your flight will follow an existing route, you may calculate trip and fuel information for individual legs or the entire route.*

SUNRISE/SUNSET	
Waypoint:	H34___
Date:	13 APR 98
Sunrise:	06:45:36
Sunset:	19:45:58

*Sunrise and sunset for any waypoint or your current position may be determined by using the sunset/sunrise calculator.*

Main Menu:  
E6-B**Vertical Navigation Function**

The last option featured on the GPS 92's E6-B menu is the vertical navigation (VNAV) function, which lets you create a rate of descent profile from your present position and altitude to a final altitude at a specified location. To use the VNAV feature, your aircraft's ground speed must be greater than 35 knots, and you must be navigating an active GOTO or route.

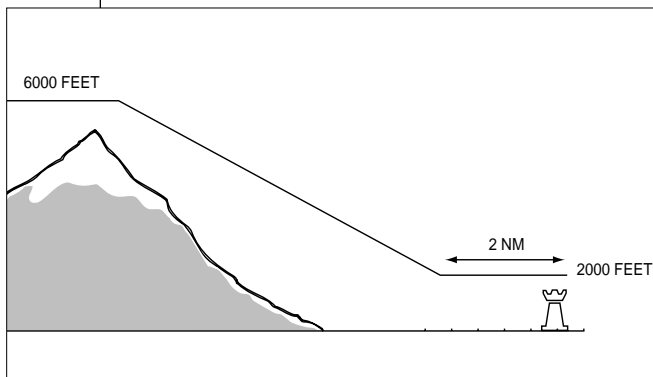
**To perform a VNAV calculation:**

1. Highlight the 'From' field and press **ENTER**.
2. Enter the initial altitude and press **ENTER**.
3. Press **ENTER**. Enter the final 'To' altitude and press **ENTER**.
4. Press **ENTER**. Enter the offset (the distance from the waypoint you'll be referencing for your final 'To' altitude) and press **ENTER**.
5. Select the 'Before' or 'After' option for the distance offset and press **ENTER** to confirm.
6. Press **ENTER**. Enter the waypoint you want to use as a reference for your final altitude. If you are navigating an active route, the waypoint field will offer the active-to waypoint for the reference waypoint (the waypoint page will appear for you to confirm).
7. Press **ENTER** to confirm the waypoint. The vertical speed for the descent will appear in the 'At' field. To select a faster or slower rate of descent, press **ENTER**, enter a new rate and press **ENTER** to confirm.

## Vertical Navigation Function (cont.)

### To activate the VNAV function:

1. Review the calculated vertical speed. If the calculated speed does not fit within the performance guidelines of your aircraft, manually enter the appropriate speed in the 'At' field and press **ENTER**.
2. Highlight the 'Vnav' field and press **ENTER**.
3. Select the 'On' setting and press **ENTER**.

The VNAV status at the bottom of the page will change from 'Enter Profile' to 'Begin In \_\_\_\_\_', indicating the time remaining to begin the descent. Once you are less than 15 seconds from the starting point of the descent, you'll be informed with a 'Start Altitude Change' message.

If the maneuver has already started, the status field will display a 'Navigating' status. While the VNAV function is active, the vertical navigation page will provide a continuous display of the recommended altitude you should be at (the 'From' field) and the vertical speed required (the 'At' field) to complete the maneuver. The recommended altitude during any active VNAV maneuver is also displayed at the bottom right of the navigation page.

When the recommended altitude is within 1,000 feet of the final altitude, you'll be informed with a 'Final Altitude Alert' message.

The VNAV function will be cancelled automatically if the active route or GOTO is changed in any way (e.g., performing an on-route GOTO or adding a waypoint to a route). Whenever this happens, you'll be informed with a 'VNAV Cancelled' message.

If your current speed does not exceed 35 knots, or a route waypoint that has already been passed is selected, the status line will display 'Invalid Profile'. If there is no active GOTO or route, the status field will display 'No Active Waypoint'.

**Main Menu:  
E6-B**

VERTICAL NAV	
From:	2500ft
To:	1800ft
By:	1.0%
Before	
Wpt:	3R9
At:	250fpm
Vnav:	On?
<b>Enter Profile</b>	

*While on an active GOTO or route, you may create a vertical decent profile by using the VNAV function.*

VERTICAL NAV	
From:	2484ft
To:	1800ft
By:	1.0%
Before	
Wpt:	3R9
At:	250fpm
Vnav:	On
<b>Navigating</b>	

*Once the VNAV function has been initiated and you've reached your descent point, a 'Navigating' status will appear at the bottom of the page.*

## Main Menu: User Waypoint List



The GPS 92 can store up to 500 user waypoints. To view a user waypoint's information page, highlight the waypoint name and press ENTER.

## User Waypoint List

The last three options on the main menu are the 'User Wpt List', 'Routes', and 'Messages'. The user waypoint list provides you with a complete list of all user waypoints stored in the GPS 92. The total number of used and empty waypoint memory locations is indicated at the top of the page. From the user waypoint list, you can quickly GOTO a selected waypoint, review a selected waypoint's information page or delete all user waypoints.

### To select a waypoint as a GOTO destination:

1. Highlight the desired waypoint and press **GOTO NEXT**.
2. Press **ENTER** to activate the GOTO.

### To review the information page of a listed waypoint:

1. Highlight the desired waypoint and press **ENTER**.
2. To return to the waypoint list, press **ENTER** again.



### To delete all user waypoints:

1. Highlight 'DELETE WPTS?' and press **ENTER**.
2. Highlight 'Yes?' and press **ENTER**.



## Routes Submenu

The routes option is covered in the routes section on page 33.

## Messages Page

The message page displays all current messages in the GPS 92. There are two types of messages: temporary alerts (e.g., approaching a waypoint) and condition alerts (e.g., battery power is low). All messages are initially indicated by a flashing on-screen indicator.

After a temporary alert has been viewed, it is cleared from the message page. Condition alerts are displayed on the messages page until the condition has been resolved. For a complete list of messages, see Appendix C.



### To view a new message:

1. Once a message alert has been provided, press **PAGE** to display the message.
2. Press **PAGE** again to return to the previous display.

### To view the messages page:

1. Highlight the 'Messages' field on the main menu page and press **ENTER**. To return to the main menu page, press **PAGE**.

**Universal Yoke Mount**

An optional yoke mount is available for your GPS 92 that may be attached to the control yoke for easy access without blocking the view of the instrument panel. The clamp that comes with the yoke mount is configured to fit the control yoke of more than 90% of general aviation aircraft.

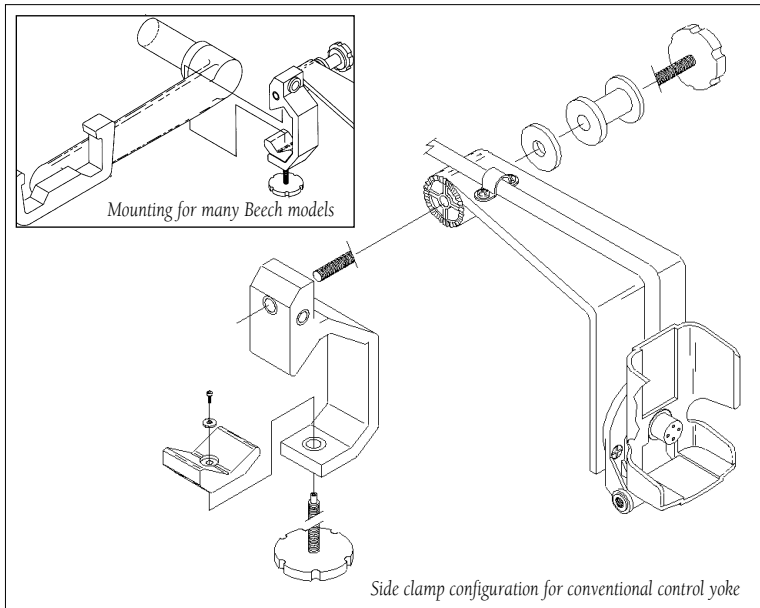
**To attach the yoke mount to the control yoke:**

1. Loosen the lower knob.
2. Slide the clamp over the control yoke shaft just behind the control wheel.
3. Tighten the lower knob securely.
4. Make sure that the clamp is as close as possible to the control wheel and check to make sure that the yoke travel is not limited or hindered in any way by the yoke mount.

5. If it is necessary to change the direction of the clamp, completely loosen and remove the upper knob, then mate up the appropriate sets of teeth so the clamp opens to the left (for conventional yokes), or toward the instrument panel (for Baron or Bonanza yokes or conventional control arms.)
6. Tighten the upper knob.
7. Loosen the clamp adjustment knob enough to slide the clamp over the control yoke shaft or arm.
8. Tighten the clamp over the control yoke shaft or arm using the clamp adjustment knob.

The yoke mount includes a bracket holder which is used to secure the GPS 92 during flight.

#### To secure the GPS 92 into the bracket holder:

1. If you are using the power/data cable to supply unit power, make sure the power/data cable is properly installed in the mounting bracket (see right) before inserting the GPS 92 into the bracket.
2. If the power/data cable is installed into the bracket, open the rubber plug on the back of the unit. Once the unit is properly connected, the GPS 92 will run off external power and the battery level indicator will no longer appear on the status page.
3. Press the GPS 92 firmly into the mounting bracket until the unit snaps into place.

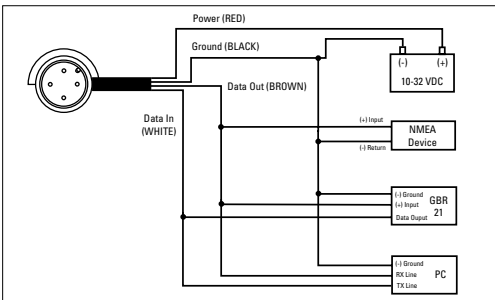
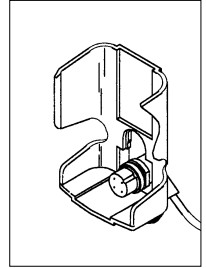

The GPS 92's power/data cable allows you to operate the unit using 10-32 volts DC power and connect to external devices, such as a PC or another GPS 92 (for data exchange). Connections are provided for power, ground, data, output and data input, as shown in the diagram above.

**Specifications**

The GPS 92 is constructed of high-quality materials and should not require user maintenance. Should your unit ever need repair, please take it to an authorized GARMIN service center. The GPS 92 has no user-serviceable parts. Never attempt any repairs yourself. To protect your GPS 92, keep it in its carrying case when not in use, and never allow gasoline or other solvents to come into contact with the case. Clean the case and lens with a soft cloth and a household window cleaner.

**PHYSICAL**

Case:	Ultrasonically welded and sealed
Size:	6.15"H x 2"W x 1.23"D (15.6 x 5.1 x 3.12 cm)
Weight:	Approx 9.5 ounces lbs. (.27 kg)
Temperature Range:	5° to 158°F (-15° to 70°C)

**PERFORMANCE**

Receiver:	PhaseTrac12™
Acquisition Time:	Approx. 15 seconds (warm start) Approx. 45 seconds (cold start) Approx. 5 minutes (AutoLocate)
Update Rate:	1/second, continuous
Position Accuracy:	1-5 meters (3.3-16 ft.) with DGPS corrections* 15 meters (49 ft.) RMS**
Velocity Accuracy:	0.1 knot RMS steady state
Dynamics:	Performs to specification to 6g's

**POWER**

Input:	Four 1.5 volt AA batteries or 10-32 VDC external
Battery Life:	Up to 24 hours (backlighting off)

Specifications subject to change without notice.

\* With optional GARMIN GBR 21 Beacon Receiver Input.

\*\* Subject to accuracy degradation to 100m 2DRMS under the US DOD-imposed Selective Availability Program.

The GPS 92 uses a flashing on-screen message indicator to alert you to important information. Whenever the message indicator appears, press **PAGE** to view the message page. There are two types of messages: temporary alerts and condition alerts. Temporary alerts are cleared from the message page after viewing, while condition alerts remain until the condition has been resolved. Pay careful attention to all messages for your own safety.

**Accuracy has been Degraded**—The accuracy of the receiver has been degraded beyond 500 meters due to poor satellite geometry or data quality. You should check other navigational sources to verify the position indicated.

**Active WPT Can't Be Deleted**—You have attempted to change the 'Active To' or 'Active From' waypoint. Clear the active route or GOTO before making your changes.

**Already Exists**—The name you are entering already exists in memory.

**Approaching**—You are one minute away from reaching a destination waypoint.

**Arrival At**—You are within the arrival alarm distance of the indicated waypoint.

**Battery Power is Low**—The batteries are low and should be replaced.

**Cannot Navigate Locked Route**—You have attempted to navigate a route with a locked waypoint. A waypoint can be 'locked' when the database is updated if the waypoint does not exist in the new database.

**CDI Alarm**—Your course deviation has exceeded the limit specified on the alarms setup page.

**Database Memory Has Failed**—The internal memory for the Jeppesen database has failed. Take the unit to an authorized GARMIN service center.

**Final Altitude Alert**—The current altitude is within 1000 feet of the final altitude entered on

the VNAV page.

**Inside SUA**—Your aircraft has entered the boundaries of special-use or controlled airspace.

**Leg Not Smoothed**—The upcoming route leg is too short for smooth waypoint transitions.

**Memory Battery is Low**—The battery that sustains user memory is low and should be replaced by an authorized service center as soon as possible. Failure to do so may result in loss of stored data, including all user waypoints and routes.

**Near SUA < 2 nm**—Your position is within 2 nautical miles of an SUA, and your current course will not take you inside.

**Need 2D Altitude**—The unit needs altitude input in order to start and/or continue 2D navigation.

**Need to Select Init Method**—You must select an initialization method so the unit can locate satellites and obtain a position fix.

**No DGPS Position**—Not enough data is available to compute a DGPS position.

**No Position**—An attempt was made to create an AutoStore waypoint without a current position fix. Wait for the unit to obtain enough satellites to calculate a fix.

**No RTCM Input**—The beacon receiver is improperly connected or baud rates do not match.

**Oscillator Needs Adjustment**—The unit has

## Messages

detected excessive drift in its internal crystal oscillator which may result in longer acquisition time. Take the unit to an authorized service center.

**Poor GPS Coverage**—The unit cannot acquire the necessary number of satellites to compute a position. Try another location with a clearer view of the sky.

**Power Down and Re-init**—The unit is not able to calculate a position due to abnormal satellite conditions. Turn the unit off and verify the last position shown by other means. Try the unit again later, possibly in a different location.

**Read Only Mem has Failed**—The permanent memory has failed and the unit is not operable. Take the unit to an authorized service center.

**Received an Invalid WPT**—A waypoint was received during upload transfer that has an invalid identifier.

**Route Waypoint Can't be Deleted**—The waypoint you are trying to delete is part of a route. Delete the waypoint from the route before removing it from memory.

**Receiver has Failed**—A failure in receiver hardware has been detected. If this message persists, take the unit to an authorized dealer.

**Route is Full**—You have attempted to add more than 30 waypoints to a route.

**Route is not Empty**—You have attempted to copy into a route already in use.

**Route Waypoint was Deleted**—A route waypoint entered does not exist in the database and has been deleted from the route.

**RTCM Input has Failed**—DGPS data being

received has been lost. You are no longer receiving the beacon signal.

**Searching the Sky**—The unit is in searching the sky for almanac data or the unit is in AutoLocate mode.

**Start Altitude Change**—The altitude change entered on the VNAV page is about to begin.

**Steep Turn Ahead**—This message appears approximately one minute prior to a turn that requires a bank angle in excess of 25 degrees in order to stay on course.

**Stored Data was Lost**—All waypoints, routes, time and almanac data has been lost due to battery failure or clearing the receiver's memory.

**SUA Ahead < 10 min**—Your projected course and current altitude will place you within a SUA within 10 minutes, based on your current track over ground.

**SUA Near and Ahead**—Your present position is within 2 nm of a SUA based upon your current course and altitude.

**Timer Has Expired**—The countdown timer has expired.

**Track Memory is Full**—You have used all 2048 track log points in memory. Delete unwanted track data to make room for new entries.

**Transfer has been Completed**—The receiver is finished uploading or downloading information to the connected device.

**Vertical Nav Cancelled**—The VNAV function has been cancelled due to a change in the active route.

**WPT Memory is Full**—You have used all 500 waypoints. Delete unwanted waypoints to make room for new entries.

## Map Datums

The following list shows the map datums available for the GPS 92. Position/datum page abbreviations are listed first, followed by the corresponding map datum name and area. The default map datum for the GPS 92 is WGS 84.

<b>Adindan</b>	Adindan- Ethiopia, Mali, Senegal, Sudan	<b>European 1950</b>	European 1950- Austria, Belgium, Denmark, Finland, France, Germany, Gibraltar, Greece, Italy, Luxembourg, Netherlands, Norway, Portugal, Spain, Sweden, Switzerland
<b>Afgooye</b>	Afgooye- Somalia	<b>European 1979</b>	European 1979- Austria, Finland, Netherlands, Norway, Spain, Sweden, Switzerland
<b>AIN EL ABD '70</b>	AIN EL ANBD 1970- Bahrain Island, Saudi Arabia	<b>Finland Hayfrd</b>	Finland Hayford- Finland
<b>Anna 1 Ast '65</b>	Anna 1 Astro '65- Cocos Isl.	<b>Gandajika Base</b>	Gandajika Base- Republic of Maldives
<b>ARC 1950</b>	ARC 1950- Botswana, Lesotho, Malawi, Swaziland, Zaire, Zambia, Zimbabwe	<b>Geod Datm '49</b>	Geodetic Datum '49- New Zealand
<b>ARC 1960</b>	ARC 1960- Kenya, Tanzania	<b>Guam 1963</b>	Guam 1963- Guam Island
<b>Ascnsn Isld '58</b>	Ascension Island '58- Ascension Island	<b>Gux 1 Astro</b>	Gux 1 Astro- Guadalcanal Island
<b>Astro B4 Sorol</b>	Astro B4 Sorol Atoll- Tern Island	<b>Hjorsey 1955</b>	Hjorsey 1955- Iceland
<b>Astro Bcn "E"</b>	Astro Beacon "E"- Iwo Jima	<b>Hong Kong '63</b>	Hong Kong '63- Hong Kong
<b>Astro Dos 71/4</b>	Astro Dos 71/4- St. Helena	<b>Hu-Tzu-Shan</b>	Hu-Tzu-Shan- Taiwan
<b>Astr Stn '52</b>	Astronomic Stn '52- Marcus Island	<b>Indian Bngldsh</b>	Indian- Bangladesh, India, Nepal
<b>Astrln Geod '66</b>	Australian Geod '66- Australia, Tasmania Island	<b>Indian Thailand</b>	Indian- Thailand, Vietnam
<b>Astrln Geod '84</b>	Australian Geod '84- Australia, Tasmania Island	<b>Indonesia '74</b>	Indonesia 1974- Indonesia
<b>Bellevue (IGN)</b>	Efate and Erromango Islands	<b>Ireland 1965</b>	Ireland 1965- Ireland
<b>Bermuda 1957</b>	Bermuda 1957- Bermuda Islands	<b>ISTS 073 Astro</b>	ISTS 073 ASTRO '69- Diego Garcia
<b>Bogata Observ</b>	Bogata Observatry- Colombia	<b>Johnston Island</b>	Johnston Island Kandawala Kandawala- Sri Lanka
<b>Campo Inchspe</b>	Campo Inchauspe- Argentina	<b>Kerguelen Isld</b>	Kerguelen Island
<b>Canton Ast '66</b>	Canton Astro 1966- Phoenix Islands	<b>Kertau 1948</b>	Kertau 1948- West Malaysia, Singapore
<b>Cape</b>	Cape- South Africa	<b>L. C. 5 Astro</b>	Cayman Brac Island
<b>Cape Canavrl</b>	Cape Canaveral- Florida, Bahama Islands	<b>Liberia 1964</b>	Liberia 1964- Liberia
<b>Carthage</b>	Carthage- Tunisia	<b>Luzon Mindanao</b>	Luzon- Mindanao Island
<b>CH-1903</b>	CH 1903- Switzerland	<b>Luzon Philippine</b>	Luzon- Philippines (excluding Mindanao Island)
<b>Chatham 1971</b>	Chatham 1971- Chatham Island (New Zealand)	<b>Mahe 1971</b>	Mahe 1971- Mahe Island
<b>Chua Astro</b>	Chua Astro- Paraguay	<b>Marco Astro</b>	Marco Astro- Salvage Island
<b>Corrego Alegre</b>	Corrego Alegre- Brazil	<b>Massawa</b>	Massawa- Eritrea (Ethiopia)
<b>Djakarta</b>	Djakarta (Batavia)- Sumatra Island (Indonesia)	<b>Merchich</b>	Merchich- Morocco
<b>Dos 1968</b>	Dos 1968- Gizo Island (New Georgia Islands)	<b>Midway Ast '61</b>	Midway Astro '61- Midway
<b>Easter Isld 67</b>	Easter Island 1967	<b>Minna</b>	Minna- Nigeria

## Map Datums

<b>NAD27 Alaska</b>	North American 1927- Alaska	<b>Prov S Am '56</b>	Prov So Amrcin '56- Bolivia, Chile, Colombia, Ecuador, Guyana, Peru, Venezuela
<b>NAD27 Bahamas</b>	North American 1927- Bahamas (excluding San Salvador Island)	<b>Prov S Chln '63</b>	Prov So Chilean '63- S. Chile
<b>NAD27 Canada</b>	North American 1927- Canada and Newfoundland	<b>Puerto Rico</b>	Puerto Rico & Virgin Islands
<b>NAD27 Canal Zone</b>	North Am. 1927- Canal Zone	<b>Qatar National</b>	Qatar National- Qatar
<b>NAD27 Caribbn</b>	North American 1927- Caribbean (Barbados, Caicos Islands, Cuba, Dom. Rep., Grand Cayman, Jamaica, Leeward and Turks Islands)	<b>Qornoq</b>	Qornoq- South Greenland
<b>NAD27 Central</b>	North American 1927- Central America (Belize, Costa Rica, El Salvador, Guatemala, Honduras, Nicaragua)	<b>Reunion</b>	Reunion- Mascarene Island
<b>NAD27 CONUS</b>	North Am. 1927- Mean Value	<b>Rome 1940</b>	Rome 1940- Sardinia Island
<b>NAD27 Cuba</b>	North American 1927- Cuba	<b>RT 90</b>	Sweden
<b>NAD27 Grnland</b>	North American 1927- Greenland (Hayes Peninsula)	<b>Santo (Dos)</b>	Santo (Dos)- Espirito Santo Island
<b>NAD27 Mexico</b>	N. American 1927- Mexico	<b>Sao Braz</b>	Sao Braz- Sao Miguel, Santa Maria Islands (Azores)
<b>NAD27 San Sal</b>	North American 1927- San Salvador Island	<b>Sapper Hill '43</b>	Sapper Hill 1943- East Falkland Island
<b>NAD83</b>	North American 1983- Alaska, Canada, Central America, CONUS, Mexico	<b>Schwarzeck</b>	Schwarzeck- Namibia
<b>Nhrwn Masirah</b>	Nahrwn- Masirah Island (Oman)	<b>Sth Amrcn '69</b>	South American '69- Argentina, Bolivia, Brazil, Chile, Colombia, Ecuador, Guyana, Paraguay, Peru, Venezuela, Trinidad and Tobago
<b>Nhrwn Saudi A</b>	Nahrwn- Saudi Arabia	<b>South Asia</b>	South Asia- Singapore
<b>Nhrwn United A</b>	Nahrwn- United Arab Emirates	<b>SE Base</b>	Southeast Base- Porto Santo and Madiera Islands
<b>Naparima BWI</b>	Naparima BWI- Trinidad and Tobago	<b>SW Base</b>	Southwest Base- Faial, Graciosa, Pico, Sao Jorge and Terceira Islands (Azores)
<b>Obsrvtorio '66</b>	Observatorio 1966- Corvo and Flores Islands (Azores)	<b>Timbalai 1948</b>	Timbalai 1948- Brunei and E. Malaysia (Sarawak and Sabah)
<b>Old Egyptian</b>	Old Egyptian- Egypt	<b>Tokyo</b>	Tokyo- Japan, Korea, Okinawa
<b>Old Hawaiian</b>	Old Hawaiian- Mean Value	<b>Tristan Ast '68</b>	Tristan Astro 1968- Tristan da Cunha
<b>Oman</b>	Oman- Oman	<b>Viti Levu 1916</b>	Viti Levu 1916- Viti Levu/ Fiji Islands
<b>Ord Srvy GB</b>	Old Survey Grt Britn- England, Isle of Man, Scotland, Shetland Isl., Wales	<b>Wake-Eniwetok</b>	Wake-Eniwetok- Marshall Isl.
<b>Pico De Las Nv</b>	Canary Islands	<b>WGS 72</b>	World Geodetic System 1972
<b>Ptcairn Ast '67</b>	Pitcairn Astro '67- Pitcairn Isl.	<b>WGS 84</b>	World Geodetic System 1984
		<b>Zanderij</b>	Zanderij- Surinam



## Index

**A**

Accessories . . . . .	68-69
Acquiring Satellites . . . . .	8
Activating a Route . . . . .	35
Active Route Page . . . . .	36
Airport Communication Page . . . . .	22
Airport Information . . . . .	21
Airport Location Page . . . . .	30
Alarm Functions . . . . .	58
Altitude Buffer . . . . .	60
Antenna Installation/Removal . . . . .	5
Arrival Alarms . . . . .	61
Audio/Display Options . . . . .	53
Auto Zoom . . . . .	17, 45
AutoLocate . . . . .	7

**B**

Backlight Timer . . . . .	53
Battery Installation . . . . .	5

**C**

Canceling GOTO Navigation . . . . .	17
Cautions . . . . .	iv
CDI Scale . . . . .	51
Copying and Clearing Routes . . . . .	34
Creating a Route . . . . .	34

**D**

Database Updates . . . . .	57
Database Page . . . . .	7, 19
Date/Time and Timer Options . . . . .	53
Density Altitude . . . . .	64
DGPS Interface Setup . . . . .	56

**E**

E6-B Menu . . . . .	61
Entering Identifiers . . . . .	20
EZinit Prompt . . . . .	39

**F**

FSS Information . . . . .	28
---------------------------	----

**G**

GBR-21 Beacon Receiver . . . . .	56
GOTO Function . . . . .	11, 17, 30

**H**

Heading Display . . . . .	51
---------------------------	----

**I**

Initial Position Entry . . . . .	50
Initializing The Receiver . . . . .	7
Interface Setup . . . . .	55
Internal Database . . . . .	19
Intersection Information . . . . .	24
Intersection Page . . . . .	24
Inverting a Route . . . . .	34

**J**

Jeppesen database . . . . .	19, 57
-----------------------------	--------

**K**

Keypad Usage . . . . .	4
------------------------	---

**L**

Location Page . . . . .	22
-------------------------	----

**M**

Magnetic Heading . . . . .	51
Main Menu Page . . . . .	49
Map Airspace Options . . . . .	46
Map Datums . . . . .	52, 73, 74
Map Page . . . . .	41
Map Page Functions . . . . .	42
Map Options . . . . .	44
Messages . . . . .	71, 72
Messages Page . . . . .	67
Moving Map Page . . . . .	13

**N**

NDB Information . . . . .	24
Navigation Page . . . . .	12, 48
Navigation Units . . . . .	51
Nearest ARTCC Page . . . . .	28
Nearest Airports . . . . .	57
Nearest FSS . . . . .	28
Nearest Pages . . . . .	28
Nearest Waypoints Page . . . . .	17

*Index***O**

On-Route GOTOs	37
Operational Mode Page	50

**P**

Packing List	iii
Page Sequence	9
Pan Function	42
Position Format	52
Position Page	13, 40
Power/Data Cable	68
Power On	7

**R**

Range Rings	44
Receiver Status	39
Remote GPS Mount	5
Repair	iii
Reviewing & Editing Routes	36
Route Definition Page	33
Route Planning	63
Routes Submenu	67
Runway Page	23

**S**

Satellite Status Page	9, 38
Screen Contrast	53
Setup Menu	49
Signal Strength Bars	9, 38
Simulator Mode	10
Software Version	i
Specifications	70
Speed Entry	12
Sky View	38
SUAs	15
SUA Alarms	58, 59
Sunrise/Sunset Calculator	63

**T**

Time Offset	54
Timer	54
TracBack Function	47
TracBack Navigation	31
TracBack Route	47
Trip and Fuel Planning	62

**U**

User Comments	26
Unit Features	3
User Waypoint Information	25
User Waypoint List	66

**V**

Vertical Navigation	64
VOR Information Page	24

**W**

Warranty	iii
Waypoint Categories	19, 45
Welcome Page	6
Winds Aloft Function	62

**Y**

Yoke Mount	68
------------	----

**Z**

Zooming and Panning	43
---------------------	----





© 1998 GARMIN Corporation

1200 E. 151st Street, Olathe, KS USA 66062

GARMIN (Europe) LTD, Unit 5, The Quadrangle, Abbey Park Industrial Estate, Romsey, UK SO51 9AQ

GARMIN (Asia) Corp., 4th Fl., No. 1, Lane 45, Pao-Hsing Road, Hsin Tien, Taiwan R.O.C.

Web Site Address: [www.garmin.com](http://www.garmin.com)

Part Number 190-00153-00 Rev. A



Guidance by  
**GARMIN**